

1. The supplementary manual of LM-550A2 series

Install a new ribbon to the ribbon case

1. Holding the "Winding core", pull the "Ribbon core" lightly so that the adhered portion comes off.



REQUEST

- When pulling the "Ribbon core", let the core turn so that the ribbon is not gone slack.

2. While pressing "Button B," set the ribbon core (green or blue) as shown in the figure. Then, release the "Button B" to lock the ribbon.

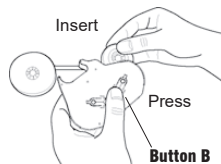

REQUEST

- Do not push too deep or too hard on the Button B.
- Pay attention to the top and bottom of ribbon case.

3. While pressing "Button A," set the winding core (black) as shown in the figure. Then, release "Button A" to lock the ribbon.

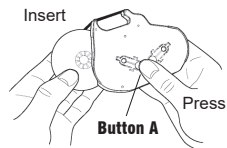

REQUEST

- Do not push too deep or too hard on the Button A.

4. Rotate the ink ribbon toward the direction of the arrow until the black surface appears. (The color changes in the order of transparent → blue → black) When the surface (black) has appeared, stop rotating.

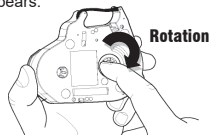

The color changes.

REQUEST

- Make sure the ribbon is not slack.

How to load consumables

1. Open the cassette cover.

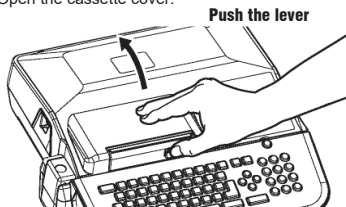

2. Push the head release lever (blue) until it stops.

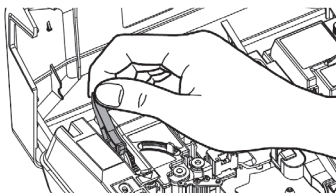

Ink ribbon

Hold the ink ribbon case as illustrated below and load it completely.

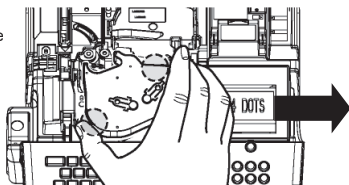

Proper loading

Press it lightly, to check it is set completely.

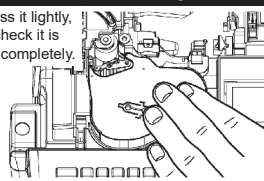

Tube

- Slide the M roller lever (Silver) to the right until it stops.

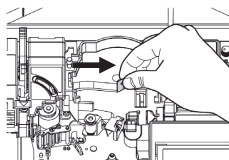

- Load the tube according to the figure below.

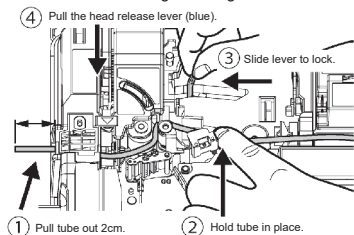

Note

Check the curl of the tube and load it in the curl angle shown below.

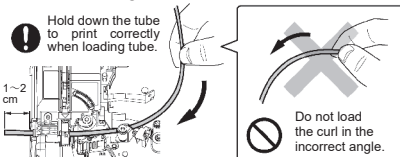

- Usable tubes are only from $\phi 1.5\text{mm}$ to $\phi 8.0\text{mm}$
- Do not use the tube that has been bent, crushed or badly stained, in order to avoid tube jamming or any other trouble on the machine.
- In case of some generic tubes, the machine cannot print them correctly.
- **To print $\phi 7.0 - \phi 8.0\text{mm}$ tube, please set the print pressure "L" (low). (See page 18 4-9 of operation manual). However, under the low temperature, low print pressure "L" may result in blur print. In such a case, please set it back to "N" (Normal print pressure).**

Tape

- Slide the M roller lever (Silver) to the left until it stops.

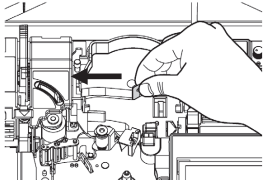

- Load the cassette tape according to the figure below.

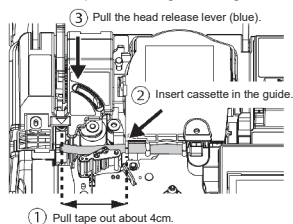

4.1mm ID Plate

- Slide the M roller lever (Silver) to the left until it stops.

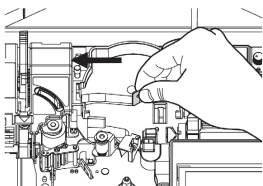

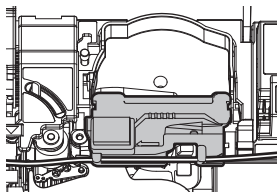

- Load the attachment for 4.1mm ID plate according to the figure below.



How to remove the jammed tube

★ If the tube is jammed, do not pull the tube by hand.

Remove the jammed tube with using the "FEED" function.

- Turn off the power. Then, open the cassette cover.
- Remove the ink-ribbon and then, slide the M roller lever (Silver) to unlock.
- While pressing , press **ON/OFF** for about 3 seconds.
Then, release ON/OFF first, while displaying the logo of "LETATWIN".
- [FEED screen] appears.
- Press  key to rotate the platen (black) roller. The jammed tube can be removed.



2. BE SURE TO READ



2-1 INTRODUCTION

Thank you for your purchasing MAX TUBE MARKER LM-550A2/PC • LM-550A2B/PC • LM-550A2BH/PC. This machine is equipped with a variety convenient features that are designed to print on tubes, tapes and ID plates. Make sure to carefully read the "Precautions for Use" and the instruction manual, in order to use the machine correctly. Since all of the notes shown here are important contents concerning safety, please carefully observe them.

2-2 PRECAUTIONS FOR USE

[Indications]

This operation manual and the machine use various indications in relation to the safe and proper operation of the machine. The indications and their meanings are as follows.

 WARNING	Negligence of this could lead to death or serious injury of an operator.
 CAUTION	Negligence of this could lead to an injury of an operator, damage to your properties, or cause created data be lost.



Describes operation, which may cause a trouble to the instrument and require a repair, or operation, which requires resetting operation, etc. to restore the condition of the instrument.



Describes the points of operation and tips.



Describes a functional precaution.

[Symbols]









: Denotes "what you should be aware of."









: Denotes "what you must not do." An indication in or near this symbol shows a specific prohibition.



: Denotes "what you must do." An indication in this symbol shows a specific instruction.

 WARNING	
	<ul style="list-style-type: none"> • Never disassemble or modify the machine — it can cause a fire, electric shock, or trouble. • Never modify the AC cord. The modified cord can lead to a fire or electric shock.
	<ul style="list-style-type: none"> • Do not put any foreign substance, such as a finger, a pen, or wire, inside the machine — it can damage the machine or cause a fire or electric shock. • Obtain power directly from an electric outlet. Do not put too much load on one electric outlet — it can cause a fire. • Never put a heavy object on a power cord — the cord can be damaged, leading to a fire or electric shock. • Do not disconnect/reconnect a power plug with a wet hand — you could receive an electric shock. • Take care not to splash water or chemicals over the machine. If any liquid should somehow get inside the machine, disconnect the power plug immediately from the electric outlet, and contact our dealer for repair. If the machine is used in that state, it may cause malfunction, damage, fire or electric shock. • Use only specified AC Adapter appended to the machine. • Never operate the machine with wet hand or with wearing wet clothes – you could receive an electric shock. • Never cover the machine with paper or cloth while the machine is connected to the electric outlet. • Do not use this machine around children.
 	<ul style="list-style-type: none"> • Do not use a machine that is out of order. If used in such condition, for example, when emitting smoke or an abnormal sound or peculiar odor, it can cause a fire or electric shock. Disconnect the power plug immediately from the electric outlet, and contact our dealer. • Never use the AC cord with leaving it bundled or winded. This may lead to a fire or damage to the AC cord. • Never use the damaged AC cord. The damaged AC cord may lead to damage to the machine, a fire or electric shock. • When disconnecting the power cord, never hold the AC cord by the cord and make sure to hold it by the plug. Pulling on the cord may lead to damage, which causes fire or electric shock. • Make sure to connect the AC plug to an electric outlet which meets the input specification of the AC adaptor. Mismatch may lead to damage of the machine, a fire or electric shock. • Make sure to clean the power plug periodically. Leaving the connected power plug without clean up may lead to accumulated dusts causing a fire or damage to the machine.
	<ul style="list-style-type: none"> • Never touch the printer head. Immediately after printing, it is very hot and it may cause burn on the hand and/or the fingers
	<ul style="list-style-type: none"> • Never touch the cutter parts (the blade of Half-cutter and Full cutter) of the instrument. Touching the cutter blades may cause serious injury.

 CAUTIONS	
	<ul style="list-style-type: none"> • Contents saved in the USB memory and in the internal memory cannot be permanently saved. Please note that we are not responsible for damages or lost profits resulting from data loss attributable to battery consumption, problems, repairs, etc.
	<ul style="list-style-type: none"> • Do not share the electric outlet with other equipment (such as air conditioner, refrigerator, microwave, office automation equipment, electrical power tools, etc.) which requires a large electrical capacity — if the voltage drops, then the machine could malfunction. • Never lick the ink ribbon, tubes and tapes. • Make sure to place the machine on the stable and horizontal work table. Avoid unstable or inclined place. It may lead to an injury or damage to the machine. • Do not touch the USB connector or power inlet. It may lead to damage of the printer by electrostatic. • This equipment is not suitable for use in locations where children are likely to be present.
	<ul style="list-style-type: none"> • When the machine will not be used for a long time period, disconnect the power plug from the electric outlet, for safety. • Prior to moving the machine to another place, make sure to disconnect the power plug. Moving the machine to another place with leaving the power plug connected may lead to damage of the power plug or the AC cord, which may result in a fire or electric shock.
	<ul style="list-style-type: none"> • When inserting/removing the USB memory, be sure to turn off the power beforehand. If the power is not turned off, an data loss or trouble may result. • When replacing the half cutter, make sure to turn off the power beforehand. Otherwise, the machine may unexpectedly operate and lead to an injury.
 	<p>Regardig battery handling Be sure to observe the following as it may cause liquid leakage, ignition, or explosion, resulting in injury or burns.</p> <ul style="list-style-type: none"> • Never disassemble, heat-up or short-out the battery. • Do not mix and use different types of batteries. • Insert the (+) and (-) direction of the battery correctly. • When not being used for a long time, remove and store the battery.

REQUEST

In order to prevent problems with the machine, follow the precautions below.

1. This machine and AC adapter are precision products. Handle them carefully, do not drop them and do not prevent them from any shock or impact.

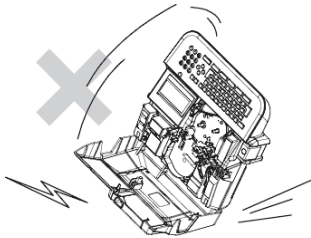

2. For the consumables other than the tubes (tape cassette, ink ribbon case, cutter, etc), use the designated products only. Never use other products.

3. When printing characters on the tubes, do not use the tubes that has been bent, crushed or badly stained. Especially, hard dirt or foreign material attached to the tubes may cause trouble of the printer head.

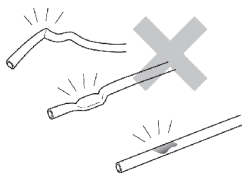

4. Do not clog the exit of the tapes and tubes. Do not insert things in it. Do not pull the tapes or tubes when it is being printed.

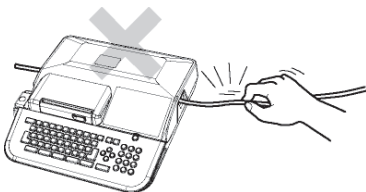

5. Do not lift up the machine holding its cassette cover. The machine may fall.

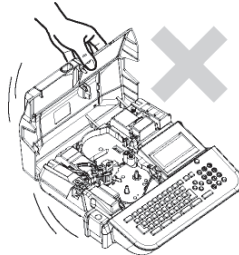

6. If there is strong external noise or shock applied to the machine during operation, abnormal displays may appear or contents of the memory may be erased.

7. Do not pull out the power cord while the power key of the main body is turned on or right after it is turned off, which may cause malfunction or trouble such as loss of contents of the setting or memory.

8. If tube is jammed, do not pull the tube by hand. Remove the jammed tube with using the "FEED" function. (page 15)

9. Do not place any heavy materials on the machine or power cord.

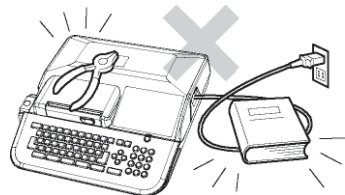

10. Do not put metal fragments or similar foreign substances in the USB port or USB memory slot, which may cause trouble due to electrostatic.

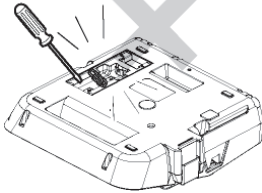

11. Do not press hard the display, which may cause fracture of the display.
12. Do not spill liquid such as coffee, juice, water on the machine.

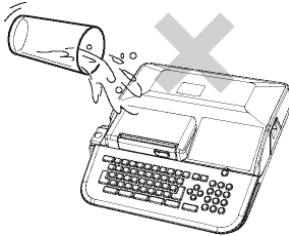

13. To clean dirt of the machine, use a soft cloth and wipe it off. When doing it, do not use organic solvents or chemicals such as thinner, benzene or alcohol, which may cause deformation or discoloration of the machine.
14. If you bring the machine from the cold outside into a warm room, there may be dew condensed within the machine due to the rapid change of the temperature. In this case, leave the machine in the room for more than 30 minutes and use it after confirming that the dew has disappeared.

15. To avoid the cause of trouble, do not use or store the machine in the following places.

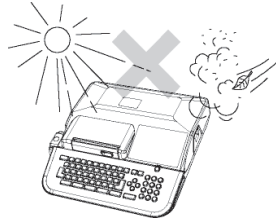

- (1) Under the direct sun light or the place near a thermal source such as a heater.
 - (2) There is a lot of dust or humidity.
 - (3) Do not use the machine in the place where the temperature becomes lower than 10°C or higher than 35°C.
 - (4) Do not store the machine in the place where the temperature becomes lower than 0°C or higher than 40°C.
16. To store or transport the machine, use the attached carrying case or package supplied to you when you bought the machine.

3. CONTENTS

1.	THE SUPPLEMENTARY MANUAL OF LM-550A2 SERIES	1
2.	BE SURE TO READ	3
2-1	INTRODUCTION	3
2-2	PRECAUTIONS FOR USE.....	3
3.	CONTENTS	8
4.	BEFORE USE	10
4-1	MAIN FEATURES.....	10
4-2	CONFIRMING THE PACKAGE CONTENTS	11
4-3	NAME OF EACH SECTION	12
4-4	NAME OF KEYS AND THEIR FUNCTIONS	13
4-5	INPUT SCREEN	15
4-6	SELECTING THE SCREEN LANGUAGE	16
4-7	CLEANING THE PLATEN ROLLER OR REMOVING JAMMED TUBE ("FEED" function)	17
4-8	ADJUSTING THE HALF CUTTING DEPTH	18
4-9	SWITCHING THE PRINTING PRESSURE.....	18
4-10	CONNECTING AC ADAPTER.....	18
4-11	USE WITH A RECHARGEABLE BATTERY (Panasonic eneloop recommended).	19
5	LOADING THE CONSUMABLES	20
5-1	INSTALLING OR REPLACING THE INK RIBBON	20
5-2	LOADING THE TUBES AND THE INK RIBBON CASE.....	21
5-3	LOADING THE TAPE CASSETTE AND THE INK RIBBON CASE	25
5-4	LOADING THE 4.1mm ID PLATE AND THE INK RIBBON CASE	27
5-5	REPLACING THE HALF CUTTER.....	29
5-6	INSERTING THE USB MEMORY (EXTERNAL MEMORY)	29
6.	BASIC OPERATION	30
6-1	PRINTING ON THE TUBE (PITCH PRINT).....	31
6-2	PRINTING ON THE TAPE	33
6-2-1	PITCH PRINT ON THE TAPE	33
6-2-2	NORMAL PRINT ON THE TAPE.....	35
6-3	PRINTING ON THE ID PLATE (PITCH PRINT)	37
7.	INPUTTING AND DELETING CHARACTERS	39
7-1	INPUTTING CHARACTERS	39
7-2	DELETING CHARACTERS.....	39
7-3	INPUTTING CHARACTERS WITH "CODE" FUNCTION	40
7-4	INPUTTING CHARACTERS WITH "DIACR" FUNCTION	41
8.	FUNCTIONS	42
8-1	SIZE	42
8-2	WIDTH	43
8-3	CHARACTER / LINE SPACE	44
8-4	PITCH PRINT	45
8-4-1	PITCH LENGTH	46
8-4-2	PITCH CUT.....	46
8-5	NORMAL PRINT	47
8-5-1	PRINTING LENGTH.....	47
8-5-2	MARGIN	47
8-6	VERTICAL	48
8-7	REPEAT.....	48
8-8	UNDERLINE	49
8-9	SEQUENCE.....	49
8-10	FRAME	50

8-11 SYMBOL.....	51
8-12 MEMORY OF WORD.....	52
8-13 IMAGE.....	54
8-14 ADVANCED SETTINGS.....	54
8-14-1 PRINTING DENSITY.....	55
8-14-2 LOW TEMP. MODE.....	55
8-14-3 FEED THE HEAD OF TUBE.....	55
8-14-4 "6, 9" MARK.....	55
8-14-5 POSITION OF PRINTING LINE.....	56
8-14-6 CUTTING POSITION.....	56
8-14-7 AUTO POWER-OFF.....	56
8-14-8 DEFAULT VALUE OF "PITCH LENGTH".....	57
8-14-9 DEFAULT VALUE OF "REPEAT".....	57
8-14-10 JUSTIFICATION.....	57
8-14-11 PRINTING STYLE OF "RPT" & "SEQ".....	58
8-14-12 LCD BRIGHTNESS.....	58
8-14-13 LCD BACKLIGHT.....	59
8-14-14 FONT CHOICE.....	59
8-14-15 REGISTER BASIC SETTING.....	60
8-14-16 PERIOD.....	60
8-15 COPY / PASTE.....	60
8-15-1 COPY.....	60
8-15-2 PASTE.....	60
8-16 INPUT ASSISTANCE FUNCTION.....	61
8-17 MEMORY.....	61
8-17-1 INTERNAL MEMORY.....	61
8-17-2 USB MEMORY (EXTERNAL MEMORY).....	63
8-18 TUBE HEATER.....	65
9. PRINTING.....	66
9-1 PRINT RANGE SETTING SCREEN.....	66
9-2 180° ROTATION PRINT.....	66
9-3 PRINTING LENGTH ALIGNMENT.....	67
9-4 CONTINUE PRINTING AFTER THE CONSUMABLES RUNNING OUT.....	67
10. EDITING DATA AND PRINTING BY A PERSONAL COMPUTER.....	68
10-1 INSTALLING "LETATWIN PC EDITOR" AND PRINTER DRIVER TO A PERSONAL COMPUTER... 68	
10-1-1 INSTALLING "LETATWIN PC EDITOR".....	68
10-1-2 INSTALLING THE PRINTER DRIVER.....	69
10-2 EDITING DATA ON A PERSONAL COMPUTER.....	71
10-3 PRINTING DIRECTLY FROM "LETATWIN PC EDITOR".....	71
10-4 SAVING DATA DIRECTLY FROM "LETATWIN PC EDITOR".....	72
11. TROUBLE SHOOTING.....	73
11-1 ERROR MESSAGE LIST.....	73
11-2 TROUBLESHOOTING.....	76
12. PRODUCT SPECIFICATIONS.....	78
13. APPENDICES.....	80
14. SPECIAL NOTICE FOR DISPOSAL(ONLY in India).....	81

4. BEFORE USE

4-1 MAIN FEATURES

- With simple operation, you can print characters directly on tubes and tapes.
- High-speed printing (up to 40mm/s) and high durability.
- MAX original application software (Letatwin PC Editor) is included.
- Data created with "Letatwin PC Editor" can be directly printed by USB connection or imported from your PC to LM-550A2/PC through USB memory.
- Bright and large backlit LCD.
- The internal memory of 250,000 characters and the external memory (USB memory as option) are available.
- Usable tubes and tapes are as follows:
 - Max genuine tubes = ϕ 2.5mm, ϕ 2.7mm, ϕ 3.2mm, ϕ 3.4mm, ϕ 3.6mm, ϕ 4.2mm, ϕ 5.2mm, ϕ 6.4mm, ϕ 8.0mm
 - Generic tubes = ϕ 1.5mm, ϕ 2.0mm, ϕ 2.5mm, ϕ 3.2mm, ϕ 3.6mm, ϕ 4.2mm, ϕ 5.2mm, ϕ 5.5mm, ϕ 6.0mm, ϕ 6.5mm, ϕ 8.0mm
 - Max grip tubes = ϕ 2.9mm, ϕ 3.7mm
 - Shrinkable tubes = ϕ 2.0mm, ϕ 2.5mm, ϕ 3.2mm, ϕ 3.6mm, ϕ 4.2mm, ϕ 5.2mm, ϕ 5.5mm, ϕ 6.0mm, ϕ 6.5mm, ϕ 6.8mm
 - Non PVC tubes = ϕ 3.2mm, ϕ 3.6mm, ϕ 4.2mm, ϕ 5.2mm
 - Oval tubes = ϕ 2.5mm, ϕ 3.2mm, ϕ 3.6mm, ϕ 4.2mm, ϕ 5.2mm, ϕ 5.5mm, ϕ 6.5mm,
 - Max genuine tapes = width: 5mm, 9mm, 12mm
 - ID Plate = width: 2.5mm, 4.1mm, 4.6mm, 6.3mm, 9.0mm
(Special attachment is required for printing on ϕ 1.5/2.0 tubes, 4.1mm ID plate and ϕ 2.9/3.7mm Max grip tubes.)
- Half cutting allows you to carry the tubes without losing and to remove tapes with ease.
- Ten key allows you to input data quickly and easily.
- Key top prints are protected with overcoat.
- Carrying case makes it easy to store away safely.
- Multiple screen languages can be selected.
- Adjustable half cutting depth with Depth adjustment lever.
- Tubes of diameter ϕ 6.8 and ϕ 8.0 cannot be half-cut. Only NO / LINE / DOTS can be selected.

4-2 CONFIRMING THE PACKAGE CONTENTS

This machine comes with the following accessories.
Confirm that they are included before using the machine.

Main unit



Carrying case



(Product Label is on the back of machine)



Ribbon case

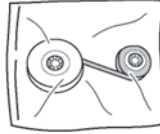

Ink ribbon: black
(for tubes and tapes)

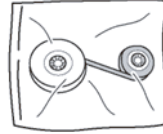

Ink ribbon : blue
(for 4.1mm ID plate and
heat shrink tubes)
(ONLY CE MODEL)

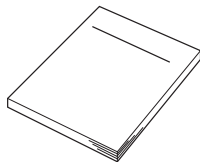

Instruction manual

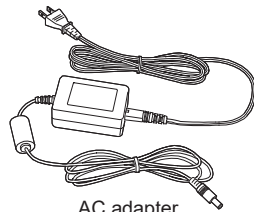

AC adapter

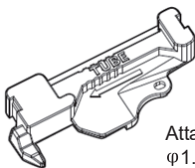

Attachment for
 ϕ 1.5/2.0mm tubes
and ϕ 2.9/3.7mm MAX Grip tubes

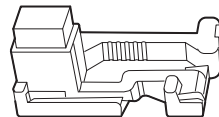

Attachment for 4.1mm ID plate
(ONLY CE MODEL)

4-3 NAME OF EACH SECTION

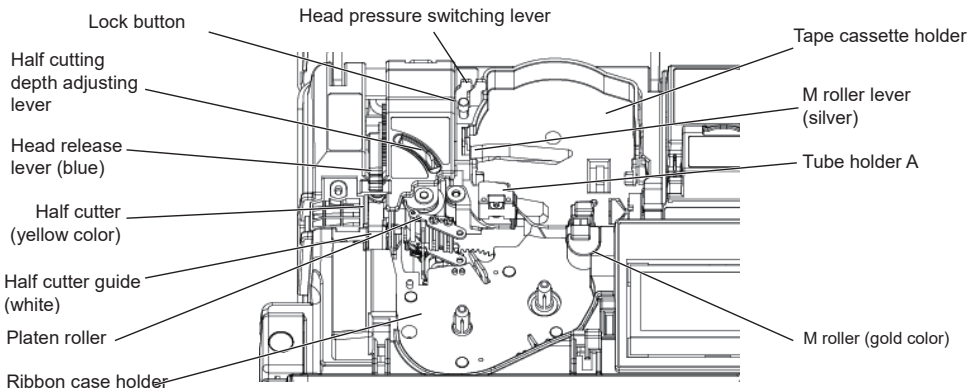
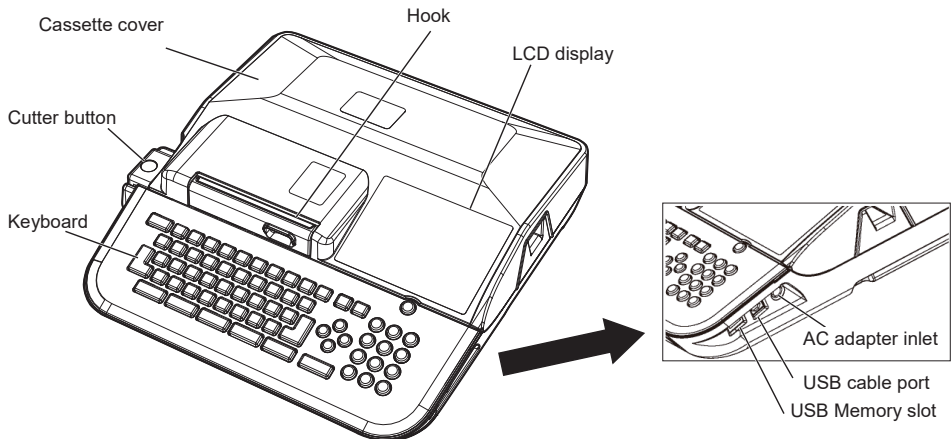

● Tape cassette

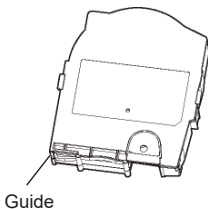

● Ribbon case

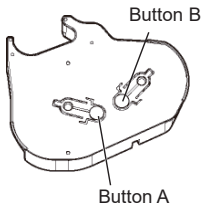

● Winding core

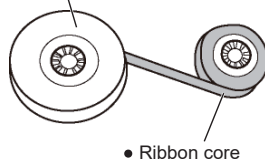

4-4 NAME OF KEYS AND THEIR FUNCTIONS

<1> Keyboard layout

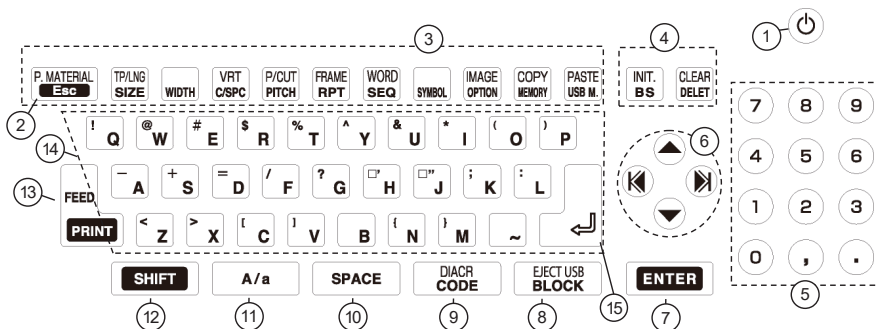

<2> Keys and their functions

1	ON/OFF	Press this key to turn ON/OFF power.
2	ESC	Press this key to return to the previous menu and not to make any changes. When printing or displaying an "IMAGE," cancel the operation.
3	P.MATERIAL (SHIFT → Esc)	Press these key to set the "PRINTED MATERIAL" when changing material without turning off power. (See 6: BASIC OPERATION)
	SIZE	Press this key to set the "SIZE" of characters. (See 8-1: SIZE)
	TP/LNG (SHIFT → SIZE)	Press these keys to set the "PRINTING LENGTH" and the "MARGIN" for the [NORMAL PRINT MODE]. (See 8-5: NORMAL PRINT)
	WIDTH	Press this key to set the "WIDTH" of characters. (See 8-2: WIDTH)
	C /SPC	Press this key to set the "CHARACTER SPACE" and "LINE SPACE." (See 8-3: CHARACTER / LINE SPACE)
	VRT (SHIFT → C/SPC)	Press these keys to set the "VERTICAL PRINTING." (See 8-6: VERTICAL)
	PITCH	Press this key to set the "PITCH LENGTH." (See 8-4: PITCH PRINT)
	P /CUT (SHIFT → PITCH)	Press these keys to set the way of "PITCH CUTTING." (See 8-4: PITCH PRINT)
	RPT	Press this key to set the repeating times and underline. (See 8-7: REPEAT) (See 8-8 : UNDERLINE)
	FRAME (SHIFT → RPT)	Press these keys to set the "FRAME." (See 8-10: FRAME)
	SEQ	Press this key to set the sequential numbers. (See 8-9: SEQUENCE)
	SYMBOL (SHIFT → SEQ)	Press these keys to operate the "SYMBOL" function. (See 8-11: SYMBOL) (See 8-12: MEMORY OF WORD)



3	OPTION	Press this key to enter “ ADVANCDE SETTINGS ”, to enter “ TUBE HEATER ”(only for the CE and A11 model), to enter “ DIRECT PRINTING FROM PC ” or to enter “ DIRECT FILE TRANSFER FROM PC ”. (See8-14: ADVANCDE SETTINGS , 10-3: PRINTING DIRECTLY FROM “LETATWIN PC EDITOR” or 10-4: SAVING DATA DIRECTLY FROM“ LETATWIN PC EDITOR”)
	IMAGE (SHIFT → OPTION)	Press these keys to display the printing image. (See 8-13: IMAGE)
	MEMORY	Press this key to operate the “ MEMORY ” function. (See 8-17-1: INTERNAL MEMORY)
	COPY (SHIFT → MEMORY)	Press these keys to copy the block indicated by the cursor. (See 8-15-1: COPY)
	USB MEM.	Press this key to operate the “ USB MEMORY ” function. (See 8-17-2: EXTERNAL MEMORY)
	PASTE (SHIFT → USB MEM.)	Press these keys to pastes the copied block to the cursor position. (See 8-15-2: PASTE)
4	BS	Press this key to delete the character just before the cursor.
	INIT. (SHIFT → BS)	Press these keys to Initialize all of the setting data. If any document is remaining in the [INPUT screen], it is unable to initialize. After deleting the entire document (press SHIFT → DELET), execute the initialization.
	DELET	Press this key to delete the character on the cursor. Press this key to initialize user default or factory default value under the function keys menu.
	CLEAR (SHIFT → DELET)	Press these keys to delete the entire documents on the [INPUT screen].
5	Ten key	Press this key to input numbers, comma and period.
6	▲/▼/◀/▶	Press these keys to move the cursor on the [INPUT screen] or change the setting items under the function keys menu.
	SHIFT → ▶ or SHIFT → ◀	Press these keys to move the cursor to the top or the end of the document.
7	ENTER	Press this key to determine the setting value on the [INPUT screen].
8	BLOCK	Press this key to insert a new “ BLOCK ” just before the cursor.
	EJECT USB (SHIFT → BLOCK)	Press these keys to eject USB memory from the machine, during the power is ON.
9	CODE	Press this key to input the code number to insert symbols. (See 7-3: INPUTTING CODE) ● When “ Chinese ” as the screen language is selected, press this key to allow you to input the Chinese character by using GB or Big 5 code.
	DIACR (SHIFT → CODE)	Press these keys to input diacritics for European languages. (See 7-4: INPUTTING DIACR)
10	SPACE	Press this key to input a space.

11	A/a	Press this key to switch capital letters to small letters, or vice versa.
	SHIFT → A/a	Recalls the character entered immediately before.
12	SHIFT	Press this key to access secondary characters on the key or the secondary functions of group (3), (4), (8), (9) and (13).
13	PRINT	Press this key to move to the "PRINT" function.
	FEED (SHIFT → PRINT)	Press these keys to feed tubes, tapes or ID plates.
14	Character keys	Press these keys to input characters.
15		Press this key to change lines.



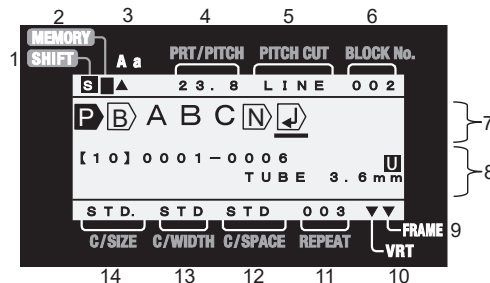

4-5 INPUT SCREEN

Screen layout



1	SHIFT	Displays  when "SHIFT" is pressed, and it goes off when "SHIFT" is pressed again.
2	MEMORY	Displays  when USB memory is inserted and when it is accessible.
3	A, a	"A" is turned on. : Enables inputting capital letters "a" is turned on. : Enables inputting small letters.
4	PRT/PITCH	In [PITCH PRINT MODE], display the "PITCH LENGTH." (See 8-4: PITCH PRINT) In [NORMAL PRINT MODE], displays the "PRINT LENGTH." (See 8-5: NORMAL PRINT)
5	PITCH CUT	Displays the way of the "PITCH CUTTING." (See 8-4-2: PITCH CUT)
6	BLOCK No.	Displays the "BLOCK NO." on the cursor.
7	INPUT screen	Displays the characters entered and the edit marks.
8	STATUS screen	The upper field displays the status of the sequential number if it has been set. The lower field displays the printed material.  Indicates that the underline has been set.
9	FRAME	Displays when the framing is "ON." (See 8-10: FRAME)
10	VRT	Displays when the vertical printing is selected. (See 8-6: VERTICAL)
11	REPEAT	Displays the repeating numbers of the block on the cursor. (See 8-7: REPEAT)
12	C/SPACE	Displays character space. (See 8-3: CHARACTER/LINE SPACE)
13	C/WIDTH	Displays the character. (See 8-2: WIDTH)
14	C/SIZE	Displays the character size of the block on the cursor. (See 8-1: SIZE)

The meanings of edit symbols displayed on the screen are as follows.



- (1)  : Represents the [PITCH PRINT MODE] activated. Represents a group of blocks with same pitch length until next [P] symbol. (See 8-4: PITCH PRINT)
- (2)  : Represents the block. Up to 999 blocks can be input in an entire document. (See 8-4: PITCH PRINT)
- (3)  : Represents the line feed.
 - (Printing on tubes) ϕ 1.5 to ϕ 3.6 : Only 1 line can be set.
 - ϕ 4.2 to ϕ 8.0 : Up to 2 lines can be set, provided 2mm character size is used. (for ϕ 4.2 tubes, the line space must be set to CNT (contact).)
 - ϕ 5.2 to ϕ 8.0 : Up to 3 lines can be set, provided 1.3mm character size is used. (for ϕ 5.2 tubes, the line space must be set to CNT (contact). Underline and frame are set appropriately.)
 - (Printing on tapes) Up to 3 lines can be set, provided 9mm and 12mm tape and 2mm or 1.3mm character size are used. Underline and frame are set appropriately.
- (4)  : Represents the SEQUENCE is set. (See 8-9: SEQUENCE)

4-6 SELECTING THE SCREEN LANGUAGE

Multiple screen languages can be selected, according to the model type of your machine.

Model type	Language
LM-550A2/PC A11-T LM-550A2BH/PC A11	English or Chinese(T) (Traditional Chinese Character)
LM-550A2/PC A12-C LM-550A2BH/PC A12-C LM-550A2/PC A12-TH LM-550A2/PC BS LM-550A2/PC SASO LM-550A2/PC C72 LM-550A2/PC (IND) LM-550A2B/PC (IND)	English or Chinese(C) (Simplified Chinese Character)
LM-550A2BH/PC CE	English, German, French, Italian, Spanish, Polish, Russian, or Turkish

[HOW TO SELECT]

1. Turn the power on, while pressing  and  at the same time. The [LANGUAGE MODE screen] appears after displaying the LETATWIN logotype.

[LANGUAGE MODE screen]



2. Select the language by using $\blacktriangle/\blacktriangledown$ key. And then press , the power supply automatically turns off.
3. Turn the power on again, then it starts up with the language selected.

Note: • When selecting English, you can neither input nor print Chinese characters.

4-7 CLEANING THE PLATEN ROLLER OR REMOVING JAMMED TUBE (“FEED” function)

1. Open the cassette cover.
2. While pressing **C**, press **ON/OFF** for about 3 seconds.
Then, release **ON/OFF** first while displaying the logo of “LETATWIN.”

3. **[FEED screen]** appears.

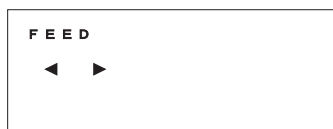

4. Slide the switching lever (silver) to the right until it stops, as shown in the figure.

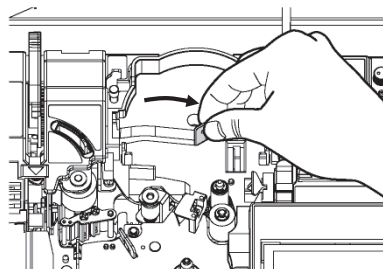

5. Put wet cloth with water or alcohol to the platen roller and clean it using ◀▶ key.

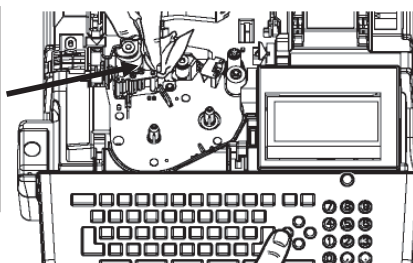
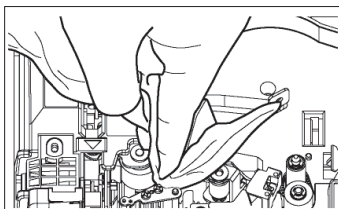

Note: If the tube is jammed, remove the consumables using this “FEED” function. Do not pull the tube by hand.

4-8 ADJUSTING THE HALF CUTTING DEPTH

Half cutting depth can be adjusted with the "Half cutting depth adjustment lever", when half cutting depth is not adequate.

Note:

- When printing on tubes, the lever has to be positioned on the "TUBE."
- When printing on tape or ID plate, the lever has to be positioned on the "TAPE" choice.

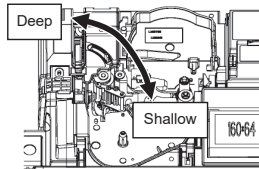

4-9 SWITCHING THE PRINTING PRESSURE

Printing pressure can be adjusted with the "Printing pressure switching lever."

Note: You don't need to change the strength unless the printed result is too dark.

(Changing from the standard pressure to the low pressure)

1. Check that the release lever is at the middle position. (The lever is standing)
2. While pressing the lock button, then slide the printing pressure switching lever to the right.
3. Now, the strength of the printing pressure is low.

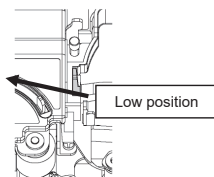
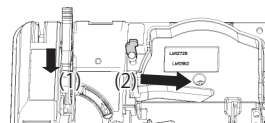

(Changing from the low pressure to the standard pressure)

1. Check that the release lever is at the middle position. (The lever is standing).
2. Press the lock button.

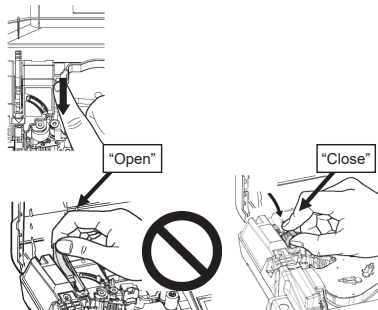

Note: Don't change the head pressure when the head release lever is positioned as the figure ("Open" position or "Close" position).

4-10 CONNECTING AC ADAPTER

1. Insert the AC adapter jack firmly into the connection part on the right side of the main unit.
2. Insert the power plug of the AC adapter into the outlet/power point .

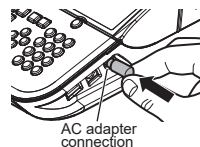

4-11 USE WITH A RECHARGEABLE BATTERY (Panasonic eneloop recommended). (only for the LM-550A2BH/PC CE, LM-550A2BH/PC and LM-550A2B/PC(IND) model)

When using with batteries, rechargeable nickel-metal hydride batteries can be used [recommended: eneloop standard model AA (BK-3MCC) x 4: sold separately]. It is convenient because data being entered can be saved at worksites without power or even if it's temporary power blackouts.

When using battery power, a  mark will be displayed on the screen.

1. Remove the battery cover on the bottom of the main unit. Lift the battery cover by pulling the knob toward you.

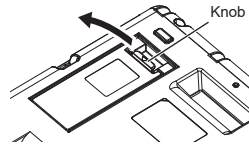

2. Insert the battery paying attention to the + and - direction.

Please use a rechargeable nickel-metal hydride battery [recommended: eneloop standard model AA (BK-3MCC) x 4: sold separately].

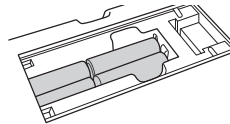

3. Align the packing of the battery cover with the groove on the bottom of the main unit, and fit it firmly.

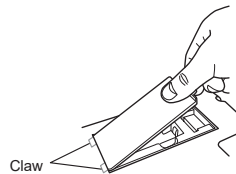

Note: · Please use eneloop standard model AA (BK-3MCC) x 4 rechargeable batteries.
(Recommendation)

Please note that if you use other batteries or rechargeable batteries, the printer performance may not be fully realized, and it may not operate normally.

· When using other rechargeable batteries, please contact your local distributor.

Batteries are not included with this unit from the manufacturer.

Please use eneloop standard model AA (BK-3MCC) x 4 from Panasonic Corporation.

(Recommendation)

· This unit does not have a battery charging function. Please Be sure to use the dedicated charger to charge the battery.

· Be sure to turn off the power before setting or replacing the battery.

You can make about 500 marked tube blocks when fully charged.

The tube heater cannot be used when using batteries.

At low temperatures (15 ° C or less), battery performance may deteriorate and normal operation may not be possible, so be sure to use the AC adapter.

* [eneloop] is a registered trademark of the Panasonic.

5. LOADING THE CONSUMABLES

Follow the steps below.

- (1) Installing the ink ribbon to the ink ribbon case.
- (2) Loading the tube or tape.
- (3) Loading the ink ribbon case.

5-1 INSTALLING OR REPLACING THE INK RIBBON

Name of each section

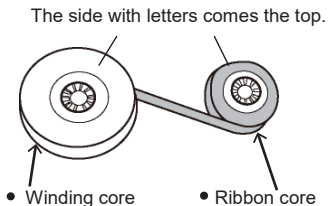
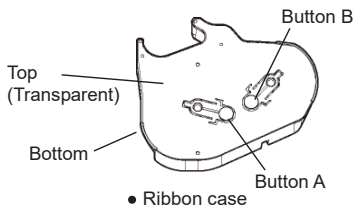

Note: Use a ribbon case (LM-RC500) for (LM-550A2 series)

Ribbon case LM-RC300 cannot be used for LM-550A2 series.

Also, ink ribbon LM-IR50B/LM-IR50W/LM-IR50BP cannot be set in ribbon case LM-RC300.

1. Install a new ribbon to the ribbon case.

1. Holding the "Winding core", pull the "Ribbon core" lightly so that the adhered portion comes off.

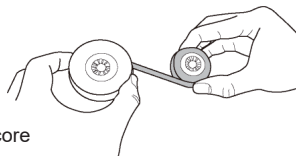

REQUEST

- When pulling the "Ribbon core", let the core turn so that the ribbon is not gone slack.

2. While pressing "**Button B**," set the ribbon core as shown in the figure. Then, release the "**Button B**" to lock the ribbon.

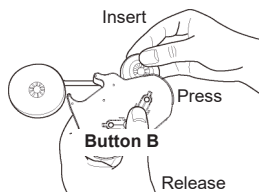

REQUEST

- Pay attention to the top and bottom of the ribbon case.

3. While pressing "**Button A**," set the winding core as shown in the figure. Then, release "**Button A**" to lock the ribbon.

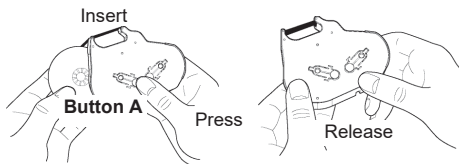

4. Rotate the ink ribbon toward the direction of the arrow until the black surface appears. (The color changes in the order of transparent → blue → black) When the surface (black) has appeared, stop rotating.

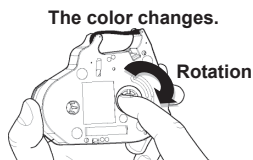

2. Replacing the ink ribbon, first remove the ink ribbon from the ribbon case.

1. While pressing "**Button B**," take out the ribbon core from the ribbon case.

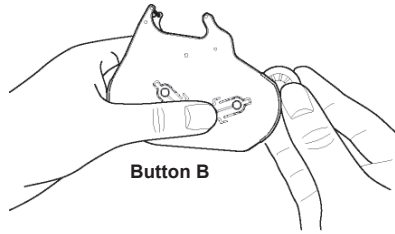

2. Next, while pressing "**Button A**," take out the winding core from the ribbon case.

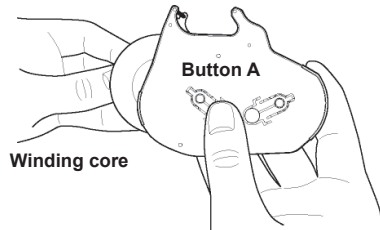

5-2 LOADING THE TUBES AND THE INK RIBBON CASE

1. Open the cassette cover.
2. Push the head release lever (blue) behind.

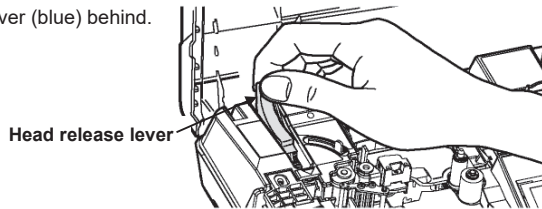

3. Slide the switching lever (silver) to the right until it stops.

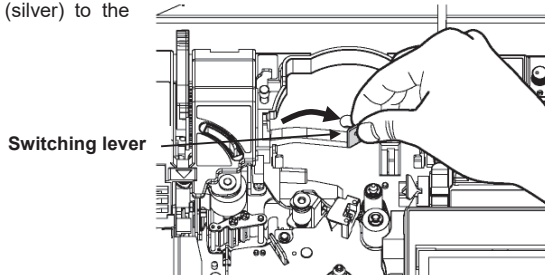

*When using $\phi 1.5/2.0$ mm tubes, and $\phi 2.9/3.7$ MAX Grip tubes set a special attachment as shown below.

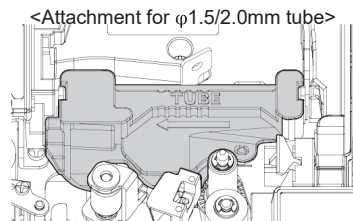

4. a: Pass the tubes under the holding plate.
- b: Extrude the tip of the tubes by 1~2cm from the machine.

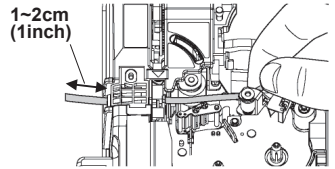
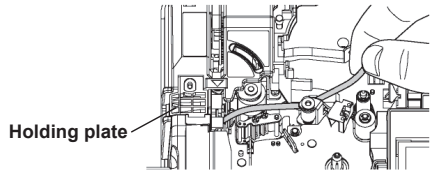
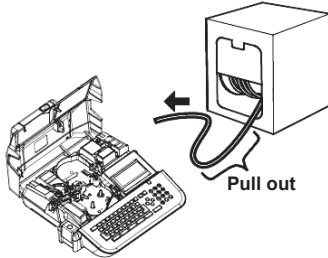

5. Place and hold the tube on the "TUBE" label and slide the "Switching lever" to lock.

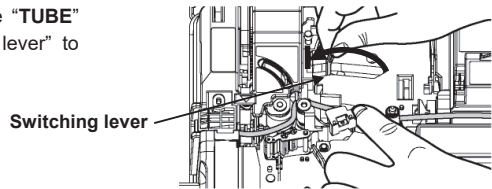

The tube has been loaded.

Make sure the tube is loaded as illustrated bellow.

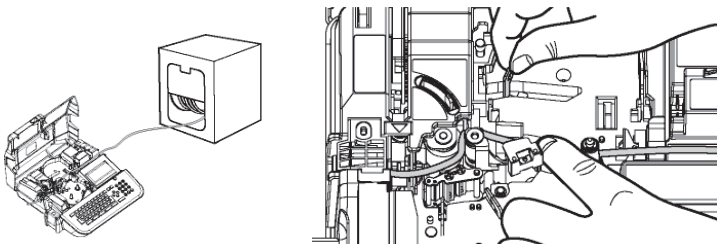

6. Make sure the ribbon is not slack.

If the ribbon is slack, rotate the winding core toward the direction of the arrow to remove the slack of the ribbon.

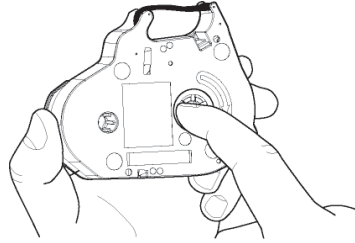

7. Hold the ink ribbon case as illustrated below and load it completely.

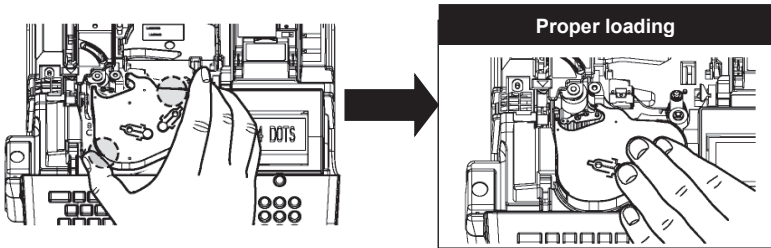

Check the slack.

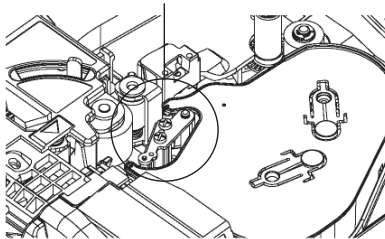

8. Pull the head release lever (blue).

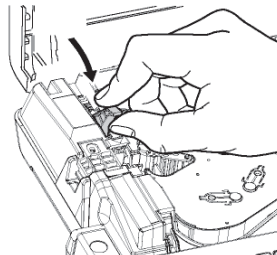

9. Close the cassette cover until it clicks.

(Removing the tube)

1. Open the cassette cover.
2. Push the head release lever behind.

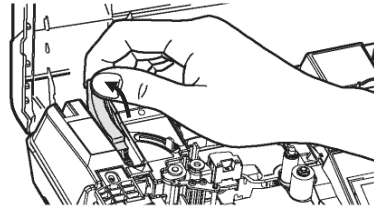

3. Slide the switching lever (silver) to the right until it stops, then remove the tube.

Note: You don't need to remove the ink ribbon case when removing tube.

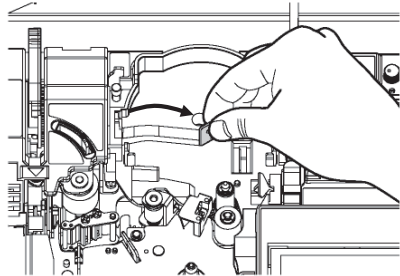

4. Pull the head release lever (blue), then close the cassette cover until it clicks.

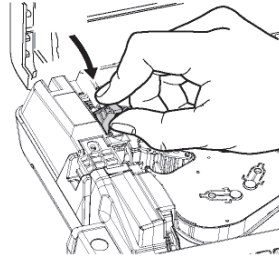

Caution

Be careful when operating the Head release lever.

If the lever is slipped off during operating the lever, it might cause the injury.

5-3 LOADING THE TAPE CASSETTE AND THE INK RIBBON CASE

1. Open the cassette cover.
2. Push the head release lever (blue) behind.

Head release lever

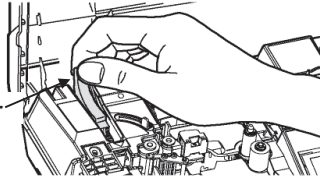

3. Slide the switching lever (silver) to the right until it stops, as shown in the figure.

Switching lever

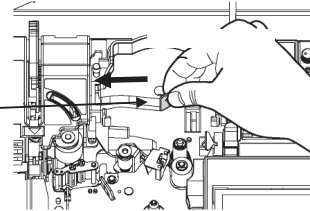

4. Load the tape cassette.

Proper loading

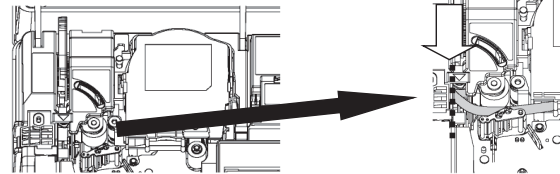
**REQUEST**

- Before loading the tape cassette, prepare it as illustrated below.

(1) Pass the tape through the guides.

(2) Pull out the tip of the tape by about 4cm (1-5/8").

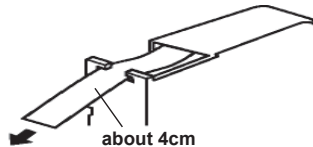
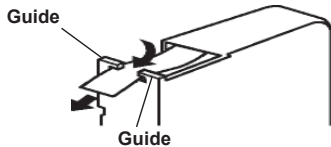

5. Make sure the ribbon is not slack.
If the ribbon is slack, rotate the winding core toward the direction of the arrow to remove the slack of the ribbon.



6. Hold the ink ribbon case as illustrated below and load it

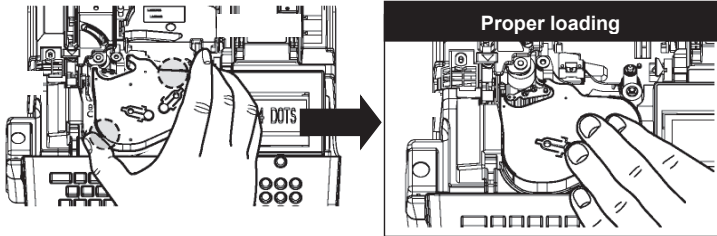

Note: Make sure the ribbon is not slack.

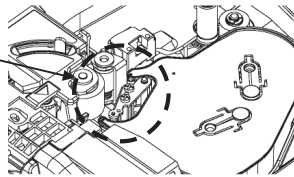

7. Pull the head release lever (blue) forward.

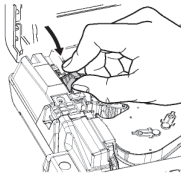

8. Close the cassette cover until it clicks.

(Removing the tape cassette)

1. Open the cassette cover.
2. Push the head release lever (blue) behind.

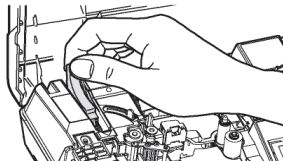

3. Remove the tape cassette

Note: You don't need to remove the ink ribbon case when removing tape cassette.

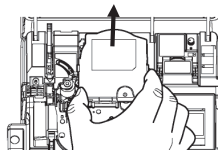

4. Pull the head release lever (blue) forward, then close the cassette cover until it clicks.

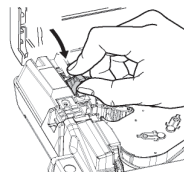

5-4 LOADING THE 4.1MM ID PLATE AND THE INK RIBBON CASE

1. Open the cassette cover.
2. Push the head release lever (blue) behind.

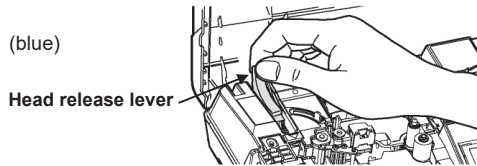

3. Slide the switching lever (silver) to the right until it stops, as shown in the figure.

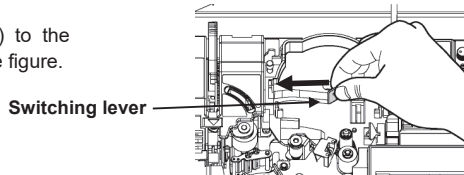

4. Prepare the 4.1mm ID plate attachment and insert the 4.1mm ID plate in the insertion slot.

*ID plate attachment is for 4.1mm width only.

*Insert the ID Plate in the winding direction as shown in the figure.

*Be sure to store the ID plate in a plastic bag, as it is prone to attract dust and dirt due to static electricity. Dust and dirt on print media may damage the print head.

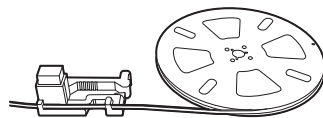

5. Set the 4.1mm ID plate attachment (with the inserted ID plate) into the machine.

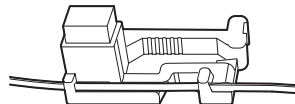

6. Pass the ID plate under the holding plate. Be sure to extend the tip of the ID plate by 1~2cm (1inch) from the machine.

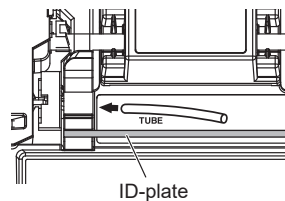
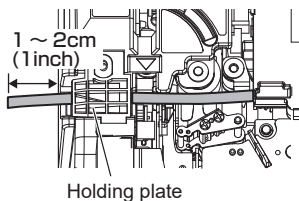
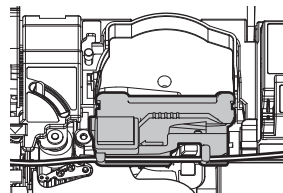

7. Make sure the ribbon is not slack.
If the ribbon is slack, rotate the winding core toward the direction of the arrow to remove the slack of the ribbon.

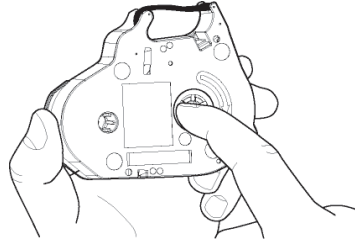

8. Hold the ink ribbon case as illustrated below and load it completely

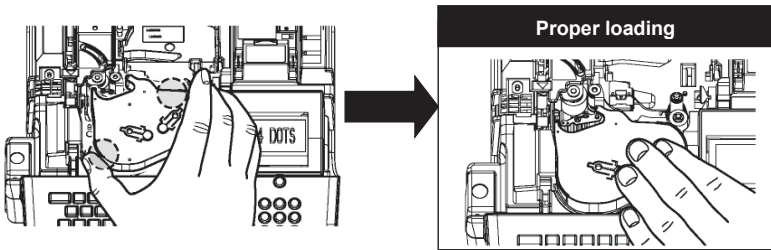

Note : Make sure the ribbon is not slack.

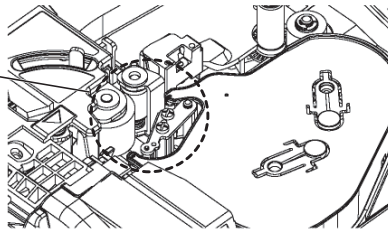

9. Pull the head release lever (blue) forward.

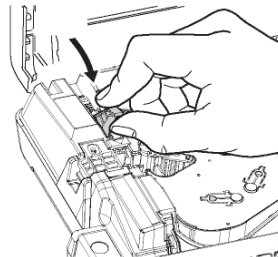



10. Close the cassette cover until it clicks.

5-5 REPLACING THE HALF CUTTER

1. Open the cassette cover.
2. Pull out the half cutter.
3. Engage the guide of the half cutter to the groove of the half cutter holder and insert it completely.

Note: If the guide is not properly engaged in the groove, the half cutter or the machine might be damaged.

Make sure to use the designated half cutter LM-HC340 (yellow color).

	Warning
	Never touch the blade of the cutter. The blade has sharp edge. Touching the blade might cause injury.

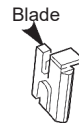

5-6 INSERTING THE USB MEMORY (EXTERNAL MEMORY)

1. Insert the USB memory with the correct side up into the USB memory slot located on the side of the unit.
2. Turn on the unit power.

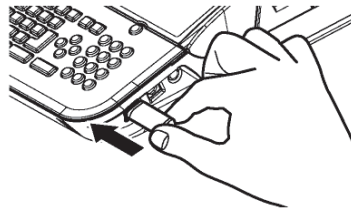

REQUEST

- To remove the USB memory, press the **EJECT USB** (**SHIFT** → **BLOCK**) first, then remove it.

6. BASIC OPERATION

1. Open the cassette cover and load the consumables to use. (See 5: LOADING THE CONSUMABLES) Then, close the cassette cover and turn the power on.

2. [PRINTED MATERIAL setting screen] appears.

Press ▲/▼/◀/▶ key to select "PRINTED MATERIAL" and "SIZE."

Press [ENTER], then [INPUT screen] appears.

```
[PRINTED MATERIAL]
MATERIAL=
MAX TUBE
SIZE=3. 2
```

▲/▼ key: Move the cursor between "MATERIAL" and "SIZE"

◀/▶ key: "MATERIAL" ... Select from "GENERIC TUBE", "MAX TUBE", "MAX GRIP TUBE", "SHRINKABLE TUBE", "NON PVC TUBE", "OVAL TUBE", "TAPE" or "ID PLATE"

"SIZE"

MAX TUBE: Select from "2.5", "2.7", "3.2", "3.4", "3.6", "4.2", "5.2", "6.4" or "8.0".

MAX GRIP TUBE: Select from "2.9", "3.7".

GENERIC TUBE: Select from "1.5", "2.0", "2.5", "3.2", "3.6", "4.2", "5.2", "5.5", "6.5" or "8.0".

SHRINKABLE TUBE: Select from "2.0", "2.5", "3.2", "3.6", "4.2", "5.2", "5.5", "6.0", "6.5" or "6.8".

NON PVC TUBE ("PVC free" TUBE): Select from "3.2", "3.6", "4.2" or "5.2".

OVAL TUBE: Select from "2.5", "3.2", "3.6", "4.2", "5.2", "5.5" or "6.5".

TAPE: Select from "5", "9" or "12."

ID PLATE: Select from "2.5", "4.1", "4.6", "6.3" or "9.0".

Note: ● When changing the material, press [SHIFT] → [Esc] (P.MATERIAL).

Then [PRINTED MATERIAL setting screen] appears.

After changing the kind of material ("TUBE" to "TAPE" or "TAPE" to "TUBE"), [PITCH LENGTH setting screen] appears. Input the desired pitch length and then press [ENTER].

- When changing the material with pressing [SHIFT] → [Esc] (P.MATERIAL), the "CHARACTER SIZE" is automatically changed to "AUTO".

However, when the selected printed material is TAPE, "CHARACTER SIZE" is not changed to "AUTO".

- If any document is remained in the [INPUT screen] before turning off the power, the right screen appears when turning the power on next time.

Press ▲/▼ key to select "INITIALIZE" or "CONTINUE."

```
FILE BEING INPUT
INITIALIZE
CONTINUE
```

6-1 PRINTING ON THE TUBE (PITCH PRINT)

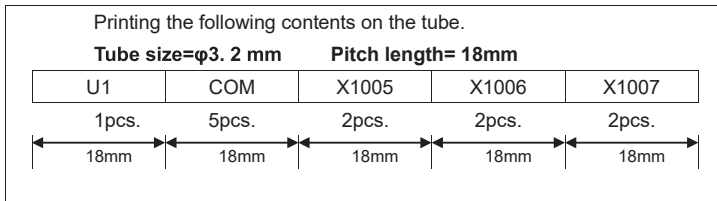

1. Set "MATERIAL = TUBE" and "SIZE = 3.2mm" in the [PRINTED MATERIAL setting screen].
2. [INPUT screen] appears. Make sure that the arrow symbol "▲" is indicating "A" = capital letters.

Press ◀/▶key to move the cursor to P.

3. Press PITCH to set "PITCH LENGTH." (See 8-4-1: PITCH LENGTH) Press ◀/▶key to set "18.0."

Press ENTER.

Note: It is also possible to input the value directly with the Ten keys.

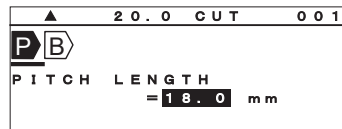

4. Press ▶key to move the cursor after B.

Press RPT to set "REPEAT." (See 8-7: REPEAT)

Press ◀/▶key to set "1." Press ENTER.

Note: It is also possible to enter the value directly with Ten key.

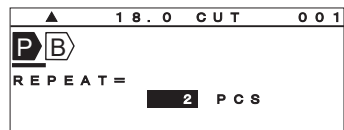

5. Input U 1. Press BLOCK to create a new block.

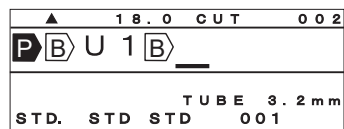

6. As same as "4", press RPT to set "Repeat" to "5." Press ENTER.

7. Input [C] [O] [M]. Press [BLOCK] to create a new block.

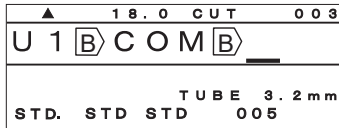

8. As same as “4”, press [RPT] to set “Repeat” to “2.”

Press [ENTER].

9. Input [X]. Press [SEQ] to set “SEQUENCE.”
(See 8-9: SEQUENCE)

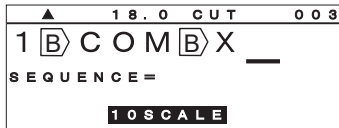

10. Press [ENTER] to select “10 scale.” Set the “START NUMBER” and “END NUMBER.”

Input [1] [0] [0] [5] in the “START.”

Press ▼ key to set the “END NUMBER.”

Input [1] [0] [0] [7] in the “END.”

Press [ENTER].

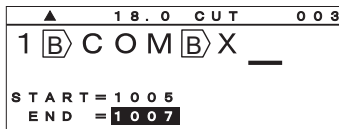

11. Select print range by pressing ← and →.

Press [ENTER].

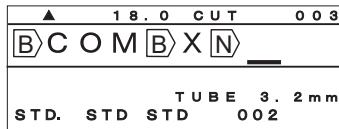

12. Press [PRINT].

[PRINTING RANGE setting screen] appears.

(See 9: PRINTING)

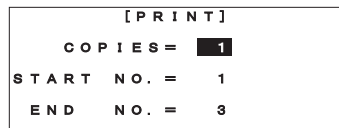

13. Press [ENTER]. [PRINT SETTING screen] appears. (See 9-2: 180° ROTATION PRINT)



14. Press [ENTER] [NORMAL PRINT].

[PRINTING LENGTH ALIGNMENT screen] appears.

Press [ENTER] to start printing.

15. The printed result is as shown below.

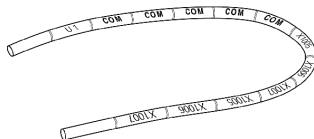

6-2 PRINTING ON THE TAPE

6-2-1 PITCH PRINT ON THE TAPE

Printing the following contents on the tape.

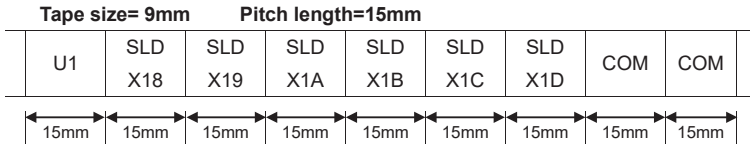

- Set **"MATERIAL=TAPE"** and **"SIZE=9mm"** in the [PRINTED MATERIAL setting screen].
- [INPUT screen] appears. Make sure that the arrow symbol "▲" is indicating "A" = capital letters.

Press ◀/▶key to move the cursor to **P**.

- Press **PITCH** to set **"PITCH LENGTH."** (See 8-4-1: PITCH LENGTH) Press ◀/▶key to set **"15.0"**

Press **ENTER**.

Note: It is also possible to input the value directly with Ten key.

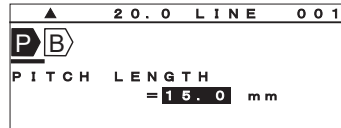

- Press ▶ key to move the cursor after **B**.

Input **U** **1**. Press **BLOCK** to create a new block.

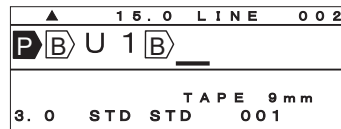

- Input **S** **L** **D** **↵**, then **X**.



- Press **SEQ** to set **"SEQUENCE."** (See 8-9: SEQUENCE)

Press ◀/▶key to select **"16 SCALE."**

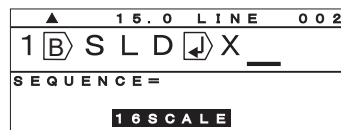

7. Pressing **[ENTER]**. Set the "START NUMBER" and "END NUMBER."

Input **[1][8]** in the "START."

Press **▼** key to set the "END NUMBER."

Input **[1][D]** in the "END."

Press **[ENTER]**.

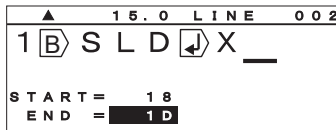

8. Select print range by pressing **←** or **→**.

Press **[ENTER]**.

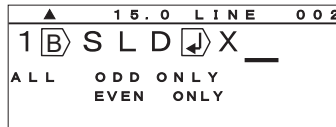

9. Press **[BLOCK]** to create a new block, and then input **[C][O][M]**.



10. Press **[RPT]** to set "REPEAT."

(See 8-7: REPEAT)

Press **◀/▶** key to set "2." Press **[ENTER]**.

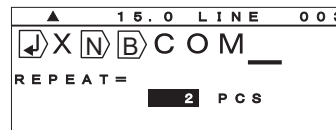

Note: It is also possible to input the value directly with Ten key.



11. Press **[PRINT]**. (See 9: PRINTING)

[PRINTING RANGE setting screen] appears.

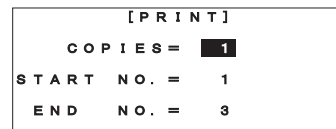

12. Press **[ENTER]**. [PRINTING LENGTH ALIGNMENT screen] appears.

Press **[ENTER]** again to start printing.

13. The printed result is as shown below.

U1	SLD X18	SLD X19	SLD X1A	SLD X1B	SLD X1C	SLD X1D	COM	COM
----	---------	---------	---------	---------	---------	---------	-----	-----

6-2-2 NORMAL PRINT ON THE TAPE

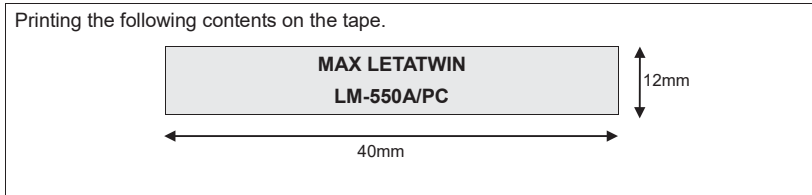

1. Set "MATERIAL=TAPE" and "SIZE=12mm" in the [PRINTED MATERIAL setting screen].

2. [INPUT screen] appears. Make sure that the arrow symbol "A" is indicating "A" = capital letters.

Press ◀/▶ key to move the cursor to P.

3. In order to change to [NORMAL PRINT MODE], press

DELET to delete P. (See 8-5: NORMAL PRINT)

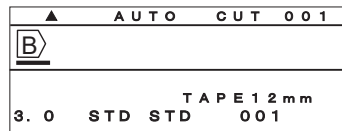

4. Press SHIFT → SIZE (TP/LNG) and set "PRINTING LENGTH." (See 8-5-1: Printing length)

Press ◀/▶ key to select "AUTO=OFF."

Then, press ▲ key to set the "LENGTH" and input 4 0.

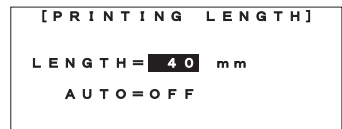

5. Press ENTER.

[MARGIN setting screen] appears.

Press ENTER.

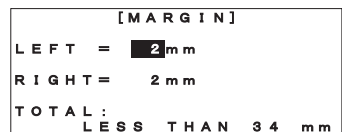

6. [INPUT screen] appears. Press ► key to move the cursor

after **B**►.

Input **M** **A** **X** **SPACE** **L** **E** **T**

A **T** **W** **I** **N** ◀►

L **M** **SHIFT** → **A** **5** **5** **0**

A **SHIFT** → **F** **P** **C**.

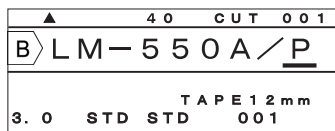

7. Press **PRINT** to start printing. (See 9: PRINTING)

8. The printed result is as shown below.



6-3 PRINTING ON THE ID PLATE (PITCH PRINT)

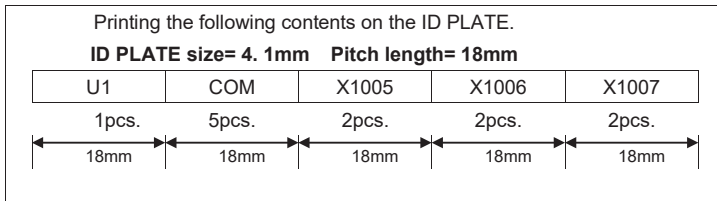

1. Set "MATERIAL = ID PLATE" and "SIZE = 4.1mm" in the [PRINTED MATERIAL setting screen].
2. [INPUT screen] appears. Make sure that the arrow symbol "▲" is indicating "A" = capital letters.

Press ◀/▶key to move the cursor to **P**.

3. Press **PITCH** to set "PITCH LENGTH." (See 8-4-1: PITCH LENGTH) Press ◀/▶key to set "18.0."

Press **ENTER**.

Note: It is also possible to input the value directly with the Ten keys.

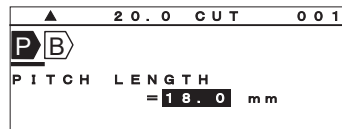

4. Press ▶key to move the cursor after **B**.

Press **RPT** to set "REPEAT." (See 8-7: REPEAT)

Press ◀/▶key to set "1." Press **ENTER**.

Note: It is also possible to enter the value directly with Ten key.

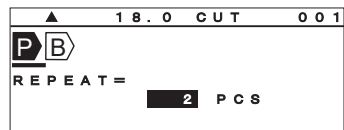

5. Input **U 1**. Press **BLOCK** to create a new block.

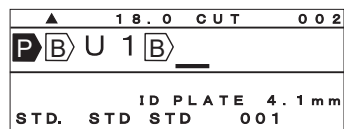

6. As same as "4", press **RPT** to set "Repeat" to "5." Press **ENTER**.

7. Input **C** **O** **M**. Press **BLOCK** to create a new block.

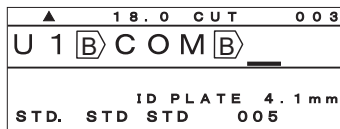

8. As same as “4”, press **RPT** to set “Repeat” to “2.” Press **ENTER**.

9. Input **X**. Press **SEQ** to set “SEQUENCE.”
(See 8-9: SEQUENCE)

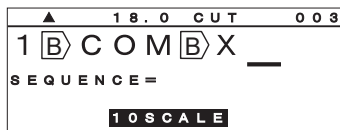

10. Press **ENTER** to select “10 scale.” Set the “START NUMBER” and “END NUMBER.”
Input **1** **0** **0** **5** in the “START.”
Press **▼** key to set the “END NUMBER.”
Input **1** **0** **0** **7** in the “END.”
Press **ENTER**.

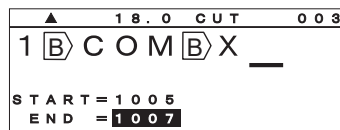

11. Select print range by pressing **←** and **→**.
Press **ENTER**.

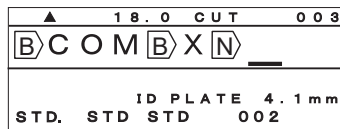
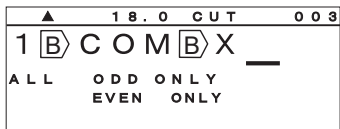

12. Press **PRINT**.
[PRINTING RANGE setting screen] appears.
(See 9: PRINTING)

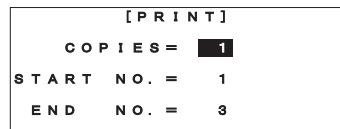

13. Press **ENTER**. [PRINTING LENGTH ALIGNMENT screen] appears.
Press **ENTER** to start printing.

7. INPUTTING AND DELETING CHARACTERS

7-1 INPUTTING CHARACTERS

1. To input the capital letter "A."

- 1) Press **A** and make sure that the arrow symbol "▲" is indicating "A" = capital letters.

2) Press **A** **P B A**

--	--	--	--	--	--	--

2. To input the small letter "a."

- 1) Press **A/a** and make sure that the arrow symbol "▲" is indicating "a" = small letters.

2) Press **A** **P B a**

--	--	--	--	--	--	--

3. To input "+."

- 1) Press **SHIFT** and check that the symbol **SHIFT** is on.

2) Press **S** **P B +**

--	--	--	--	--	--	--

7-2 DELETING CHARACTERS

1. **DELET**:

- 1) Press **DELET**.

P B A B C

--	--	--	--	--	--	--

A

--	--	--	--	--	--	--

- 2) The character on the cursor is deleted.

P B A C

--	--	--	--	--	--	--

2. **BS**:

- 1) Press **BS**.

P B A B C

--	--	--	--	--	--	--

- 2) The character before the cursor is deleted.

P B B C

--	--	--	--	--	--	--

7-3 INPUTTING CHARACTERS WITH “CODE” FUNCTION

- Using the “CODE” function, you can input the characters according to the following table.
(When English is selected as the screen language.)

[The Table of Code]

Code No.	0	1	2	3	4	5	6	7	8	9	A	B	C	D	E	F
2		!	“	#	\$	%	&	'	()	*	+	,	-	.	/
3	0	1	2	3	4	5	6	7	8	9	:	;	<	=	>	?
4	@	A	B	C	D	E	F	G	H	I	J	K	L	M	N	O
5	P	Q	R	S	T	U	V	W	X	Y	Z	[\]	^	_
6	'	a	b	c	d	e	f	g	h	i	j	k	l	m	n	o
7	p	q	r	s	t	u	v	w	γ	L	z	{		}	~	

- When selecting Chinese(C) or Chinese(T) as the screen language, you can input the Chinese characters according to “GB code” or “BIG5 code.”

(See 4-6: SELECTING THE SCREEN LANGUAGE)

[Inputting “@” with “CODE” function]

- Press [CODE]. The [CODE setting screen] appears.
- Press [4] [0] key according to the table of code, to input “@.”

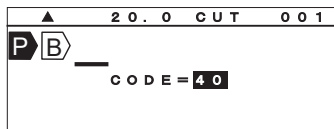

- Press [ENTER].

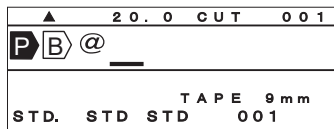

Note: You can input the characters without the table of code.

- Press [CODE] twice.
The all of characters appears.

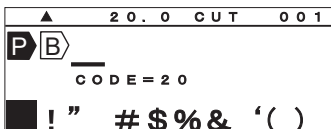

- Press ◀/▶/▲/▼ key to select the character, and then press [ENTER].

7-4 INPUTTING CHARACTERS WITH “DIACR” FUNCTION

- Using the “DIACR” function, you can input the diacritics for European and vietnamese languages. (When English / German / French / Italian / Spanish / Polish / Russian / Turkish / Vietnamese is selected as the screen language.)
- Vietnamese is not available when character size is 1.3mm.

[The Table of Diacritics for European languages and Vietnamese]

Ä	À	Á	Â	Ã	Ä	Ǻ	Ǻ	Ă	Ă
Ǻ	Ǻ	Ǻ	Ǻ	Ǻ	Ǻ	Ǻ	Ǻ	Ǻ	Ǻ
Ć	Ç	Đ	Ě	È	É	Ê	Ë	Ě	Ě
Ě	Ě	Ě	Ě	Ě	Ě	Ğ	İ	Ì	Í
Î	İ	ı	Ĭ	Ĩ	ı	Ł	Ń	Ñ	Ö
Ò	Ó	Ô	Ơ	Õ	Ỡ	Ỏ	Ổ	Ỡ	Õ
Õ	Õ	Ố	Ớ	Ọ	Ộ	Ợ	Ś	Ş	Ü
Ù	Ú	Û	Ư	Ừ	Ủ	Ử	Ū	Û	Ú
Ụ	Ự	Ỡ	Ỡ	Ỡ	Ỡ	Ỡ	Ż	Ž	Ø
Æ	Œ								
ä	à	á	â	ã	ä	Ǻ	Ǻ	ă	ă
Ǻ	Ǻ	Ǻ	Ǻ	Ǻ	Ǻ	Ǻ	Ǻ	Ǻ	Ǻ
ć	ç	đ	ě	è	é	ê	ë	ě	ě
ě	ě	ě	ě	ě	ě	ğ	ı	ì	í
î	İ	ı	ĭ	ĩ	ı	ł	ń	ñ	ö
ò	ó	ô	ơ	õ	ỡ	ỏ	ổ	ỡ	õ
õ	õ	ố	ớ	ọ	ộ	ợ	ś	ş	ü
ù	ú	û	ư	ừ	ủ	ử	ū	Û	ú
ụ	ự	Ỡ	Ỡ	Ỡ	Ỡ	Ỡ	ż	ž	ø
æ	œ	ß							

1. Press [DIACR].

The [DIACR select screen] appears.

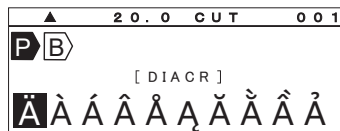

2. Press ◀/▶/▲/▼ key to select the character, and then press [ENTER].

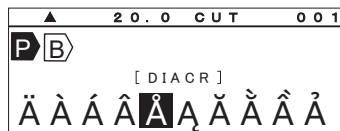

Note: ● Press ▲/▼ key to display the following 10 character.

8. FUNCTIONS

The following table shows the setting items and their default values.

SETTING ITEM	DEFAULT VALUE	SETTING ITEM	DEFAULT VALUE
<i>Printed material</i>	MAX tube	Repeat	TAPE: 1
<i>Size of printed material</i>	No setting		TUBE: 2
Character size	AUTO: ON	Sequence	No setting
Character width	STANDARD	Justification	CENTER
Character space	STD	6, 9 mark	(6 9)
Line space	STD	<i>Printing density</i>	4
Pitch length	TAPE: 10.0 mm	<i>Cutting position</i>	0.0mm
	TUBE: 20.0 mm	<i>Printing alignment</i>	0mm
	ID PLATE: 10.0 mm	<i>LCD brightness</i>	4
Pitch cut	TAPE: LINE	<i>Auto power off</i>	YES
	TUBE: HALF-CUTTING	<i>Position of printing line</i>	0
	ID PLATE: HALF-CUTTING	<i>Printing style of [RPT]&[SEQ]</i>	A: 11,22,33
Vertical or horizontal	HORIZONTAL	<i>Feed the head of tube</i>	NO
Frame	NO	<i>Low temp mode</i>	NO
Printing length	AUTO	<i>LCD backlight</i>	LIGHT
Margin	2 mm each		

- Note:**
- By pressing → (INIT.) in **[INPUT screen]**, all of setting items can be returned to the default values.
 - The italic characters show that these setting items are unable to return to the default value by initializing.

8-1 SIZE

Setting the “**CHARACTER SIZE**” of the line at the cursor position.

The size can be set in each line. But, the different sizes cannot be set in the same line of the same block.

Selectable items: “**SIZE**” = 1.3, 2.0, 3.0, 4.0, 6.0 “**AUTO**” = ON, OFF

1. Press . The **[CHARACTER SIZE setting screen]** appears.
2. Press / key to select the value of the “**CHARACTER SIZE.**”
3. Press key to move the cursor to “**AUTO.**”
Press / key to select “**OFF.**”
4. Press .

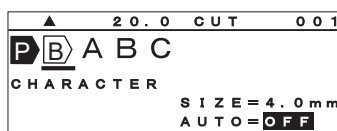
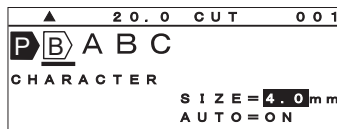

- Note:**
- Only when the “**AUTO**” is selected to “**OFF**”, the size setting is available.
 - The selectable “**CHARACTER SIZE**” varies depending on the size of the material, the “**PITCH LENGTH**” and the number of lines, etc.
 - When the “**AUTO**” is selected in the “**CHARACTER SIZE**”, the character sizes change automatically, depending on the size of material, pitch length and the number of lines in each block.

TYPES OF AUTO SIZE FUNCTION

	CHARACTER		CHARACTER SPACE LINE SPACE
	HEIGHT	WIDTH	
STANDARD AUTO	AUTO	FIXED※	CLOSE
SUPER AUTO	AUTO	AUTO	AUTO
FIXED HEIGHT AUTO	FIXED	AUTO	AUTO
OFF	FIXED	FIXED	FIXED

※The character width of 1.3 mm characters are automatically adjusted.

8-2 WIDTH

Setting the “**CHARACTER WIDTH**” at the cursor position.

Selectable items: **STANDARD, CONDENSED, EXTENDED**

Note: You can select “**CHARACTER WIDTH**” according to the following table.

PRINTING MODE	PRINTING DIRECTION	STANDARD	CONDENSED	EXTENDED
Pitch print (Tube)	Horizontal	A	A	A
	Vertical	A	A	A
Pitch print (Tape)	Horizontal	A	A	A
	Vertical	A	A	A
Normal print (Tape)	Horizontal	A	A	A
	Vertical	A	A	A

Note: For “**Vertical printing direction**”, see “**6-6: VERTICAL**”.

1. Press **[WIDTH]**. The [**CHARACTER WIDTH setting screen**] appears.
2. Press **◀/▶** key to select the “**CHARACTER WIDTH.**”
3. Press **[ENTER]**.

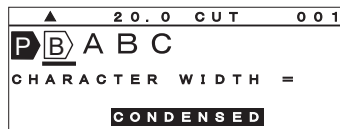

8-3 CHARACTER / LINE SPACE

Setting the "CHARACTER / LINE SPACE" for the document.

Selectable items:
 "CHARACTER SPACE" = STD (STANDARD), CLS (CLOSE), CNT (CONTACT),
 WID (WIDE)
 "LINE SPACE" = STD (STANDARD), CLS (CLOSE), WID (WIDE),
 CNT (CONTACT)

1. Press **C/SPC**. The **[CHARACTER / LINE SPACE setting screen]** appears.

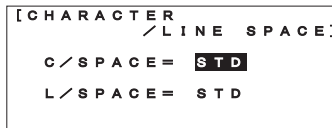

2. Press **◀/▶** key to select the value of the "C / SPACE."
 Then press **▼** key to move the cursor to the "L / SPACE."

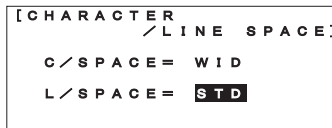

3. Press **◀/▶** key to select the value of the "L / SPACE."

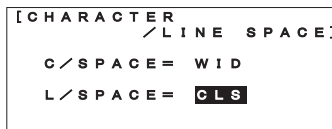

4. Press **ENTER**.

Note: In some cases, the error message ("SIZE-OVER") may appear depending on the size of the material or character, and the number of lines.

If the error message appears, check the size of the material, character and the number of lines.
 (See 11-1: ERROR MESSAGE LIST)

8-4 PITCH PRINT
[PITCH PRINT MODE]

[P] on the top of the document means that LM-550A2 series is in the **[PITCH PRINT MODE]**. By deleting the **[P]**, it switches to the **[NORMAL PRINT MODE]**.
 (See 8-5: NORMAL PRINT)

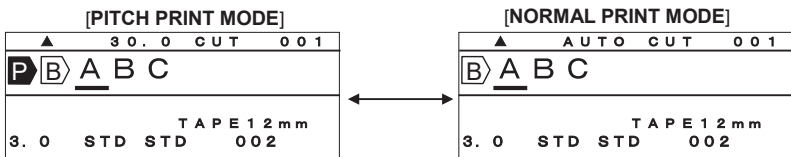

Note: In the **[PITCH PRINT MODE]**, it prints every block (**[B]**) at the same pitch length and centers the texts as illustrated below.

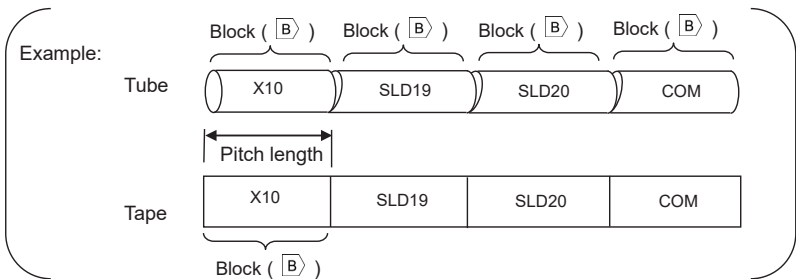

8-4-1 PITCH LENGTH

Setting the "PITCH LENGTH" at the cursor position.

Setting range : "Tube" = AUTO or 10.0 ~ 150.0mm, "ID Plate" = AUTO or 4.0 ~ 60.0mm
 "Tape" = AUTO or 3.5 ~ 60.0mm

1. Press ◀/▶ key to move the cursor under P and press PITCH.
 The [PITCH LENGTH setting screen] appears.
2. Press ◀/▶ key or Ten key to input the value of the "PITCH LENGTH."
3. By pressing ENTER, the "PITCH LENGTH" is set and the [INPUT screen] appears.

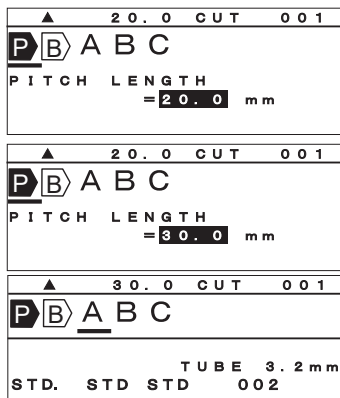

- Note:**
- Up to 999 different "PITCH LENGTH" can be set in one document.
 - The default value of "PITCH LENGTH" can be changed in the "OPTION" setting.

("AUTO" pitch function)

By pressing ▲/▼, "AUTO" is selectable as "PITCH LENGTH" for TUBE only.

Note: When "AUTO" is selected, pitch length is automatically adjusted according to the number of characters, character size, character width, etc.

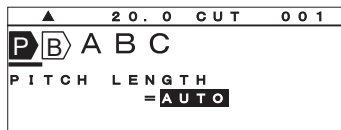

8-4-2 PITCH CUT

Setting how to divide each block.

Selectable items:							
No		LINE		DOTS		HALF-CUTTING	
ABC	123	ABC	123	ABC	123	ABC	123

1. Press SHIFT → PITCH (P/CUT).
 The [PITCH CUTTING select screen] appears.
2. Select by pressing ◀/▶/▼/▲ key and press ENTER.
 Then the [INPUT screen] appears.

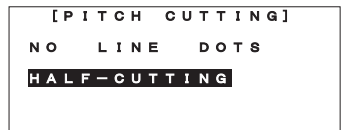

Note: "PITCH CUT" setting is not available in the [NORMAL PRINT MODE].

8-5 NORMAL PRINT

[NORMAL PRINT MODE]

In the [NORMAL PRINT MODE], the pitch print function is not available. In this mode, the maximum total printing length is 300mm.

Deleting  in the [INPUT screen].

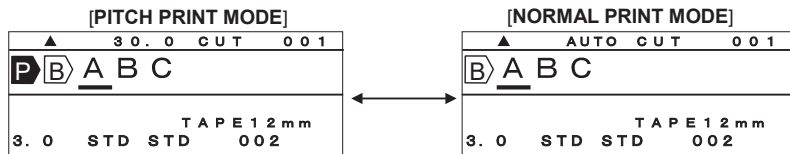

8-5-1 PRINTING LENGTH





Setting the total length of the document.

Setting range: "LENGTH" = 10~300mm, "AUTO" = ON, OFF

Note: Make sure "AUTO" is "OFF" in the [PRINTING LENGTH setting screen]. When "AUTO" is "ON," "PRINTING LENGTH" cannot be manually changed. (The "LENGTH" is shown as "____.")

1. Press  →  (TP/LNG) to display the [PRINTING LENGTH setting screen].

```
[PRINTING LENGTH]
LENGTH = 150 mm
AUTO = OFF
```

2. Press /// key or Ten key to input the value of the "LENGTH." Press . And then the [MARGIN setting screen] appears.





8-5-2 MARGIN

Setting the left and right "MARGIN" of a document.

Setting range: 2~30mm

1. After setting the "PRINTING LENGTH," the [MARGIN setting screen] appears.

```
[MARGIN]
LEFT = 2 mm
RIGHT = 2 mm
```

2. Press /// key or Ten key to input the value of the "MARGIN." Press .

8-6 VERTICAL

Setting to print the texts in the vertical orientation.

Selectable items: YES (vertical), NO (horizontal)

Note: The printed result varies depending on the selected "PRINT MODE."

You can select "PRINTING DIRECTION" according to the following table.

PRINT MODE	MATERIAL	HORIZONTAL	VERTICAL
PITCH PRINT	Tube	COM	COM
	Tape / ID Plate	COM	COM
NORMAL PRINT	Tape / ID Plate	COM	COM

1. Press [SHIFT] → [C/SPC] (VRT). The [VERTICAL setting screen] appears.



2. Press ◀/▶key to select.



3. Press [ENTER].

Note:

- Both of "VERTICAL" and "HORIZONTAL" cannot be set in a same document.
- If the error message ("SIZE-OVER") appears, check the size of the material, character size, and the number of lines. (See 11-1: ERROR MESSAGE LIST)

8-7 REPEAT

Setting the number of multiple copies of a particular block.

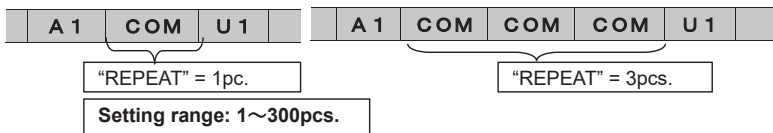

1. Press [RPT]. The [REPEAT setting screen] appears.
2. Press ◀/▶key or Ten key to input the value of the "REPEAT."
3. Press [ENTER].

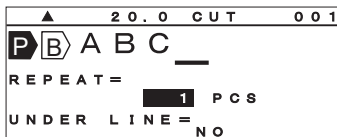
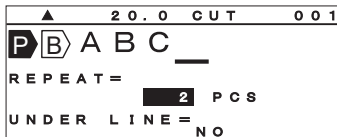

Note: The default value of "REPEAT" can be changed in the "OPTION" setting.

8-8 UNDERLINE

You can set underline function for each block.

1. Move the cursor to the block which you want to set underline, and press the **RPT** key.
2. Pressing the **▼ / ◀ / ▶** keys, set underline to - YES and press the **ENTER** key.
3. When you move the cursor to the underlined block, the underline mark is displayed on LCD.

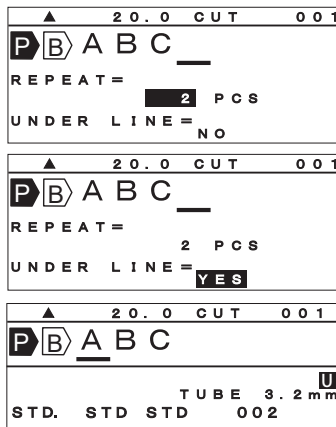

Note: Underline can be set for each block, but it is not possible to set for specific characters in the block. If [FRAME] is set, the underline can not be set.

8-9 SEQUENCE

Setting sequential (running) numbers. To activate "SEQUENCE" function, set the "START" number and "END" number as below.

If the "SEQUENCE" is set, **N** appears.

Selectable items: 8 SCALE = 0 ~7777, 10 SCALE = 0~9999, 16 SCALE = 0 FFFF, ALPHABET = A~Z, a~z

1. Press **SEQ**. The [SEQUENCE setting screen] appears.
2. After selecting the type of the "SEQUENCE" using **◀ / ▶** key, press **ENTER**. The [START and the END number setting screen] appears.
3. Press **◀ / ▶** key or Ten key to input the value of the "START."

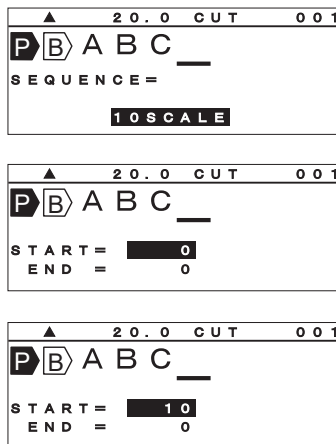

4. Press **▼** key to move the cursor to the "END." And then Press **◀/▶**key or Ten key to input the value of the "END."

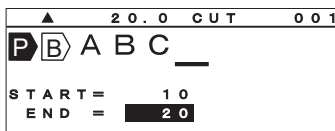

5. Select print range by pressing **←** or **→**. Press **ENTER**.

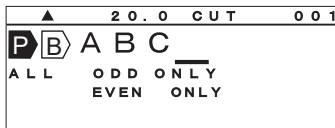

- Note:**
- Make sure to set both the "START" number and the "END" number.
 - In the [PITCH PRINT MODE], you can set three series of "SEQUENCE" in one block and up to 45 series of "SEQUENCE" in one document.
 - In the [NORMAL PRINT MODE], you can set only one series of "SEQUENCE" in one document.
 - When you change the [PITCH PRINT MODE] to the [NORMAL PRINT MODE], all the "SEQUENCE" settings are automatically cancelled except for the first "SEQUENCE" setting.
 - When sequence printing 2 or 3 prints per block, if the settings for number of prints in the block is different, the smaller number is given priority and no more prints are made.

8-10 FRAME

Setting to frame a document.

This function allows you to surround the text with a frame.



1. Press **SHIFT** → **RPT** (FRAME). The [FRAME setting screen] appears.



2. Switch item by pressing **↑**, **↓**, **←**, or **→**. Press **ENTER**.

- Note:**
- In the [PITCH PRINT MODE], the "FRAME" is applied to each block.
 - In the [NORMAL PRINT MODE], the "FRAME" is applied to the whole document.

8-11 SYMBOL

Inputting various symbols.

Selectable group of symbols:

NUMERAL, ALPHABET IN CIRCLE, UNIT, OFFICE SYMBOLS, SUPERSCRIPT, SUBSCRIPT, ELECTRICAL INSTALLATION ①~③, ITALIC, GREEK, UPPER CASE RUSSIAN and LOWER CASE RUSSIAN

Note: "LARGE RUSSIAN" and "SMALL RUSSIAN" can be displayed in the LM-550A2/PC A12-C, A11, BS, C72, IND,SASO and CE, when the screen language is English. Please check the model of your LM-550A2/PC.

2. Press **[SYMBOL]**.

The **[SYMBOL select screen]** appears.

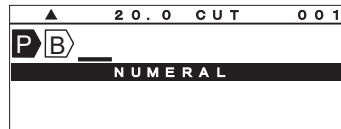

2. Press **◀/▶** key to select the group of "SYMBOLS."



3. Press **[ENTER]**. Symbols are displayed.

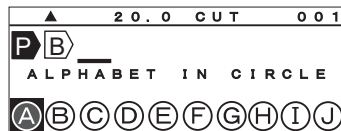

4. Press **◀/▶** key to select a desired symbol.



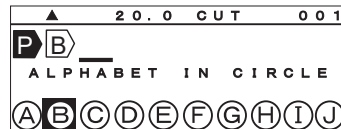

5. Press **[ENTER]** to input the symbol at the cursor position.





Note: ● Press **▲/▼** key to display the following 10 symbols.

8-12 MEMORY OF WORD

Up to 30 words can be saved in the internal memory. Up to 15 characters can be included in a word.

Note: , ,  and  cannot be saved.

1. Press  → .
- The **[MEMORY OF WORD setting screen]** appears.

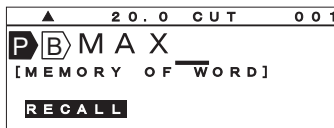

2. Press / key to select a desired item and press .



Selectable Items: RECALL, SAVE, DELETE, INITI.(INITIALIZE)

[SAVE]

Saving the "WORD."

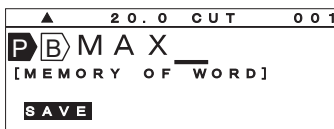

1. Select "SAVE." And then press .
- The **[STARTING POSITION setting screen]** appears.



2. Press / key to move the cursor to the first character of the word to be saved. And then press .

The **[ENDING POSITION setting screen]** appears.



3. Press / key to move the cursor to the last character of the word. And then press .

The **[FILE NO. setting screen]** appears.



4. Press / key or Ten key to input the file No.

Setting range: 1~30

5. Press  to register the selected word in the file.

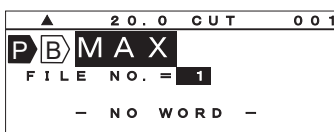

[RECALL]

Recalling the saved "WORD."

1. Select "RECALL". And then press .



2. Press ◀/▶ key or Ten key to select the desired file No.

Then the word of the desired file is displayed at the bottom of the screen.

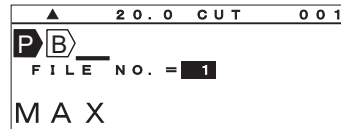

3. Press to insert the word at the cursor position.

[DELETE]

Deleting the registered "WORD."

1. Select . And then press .

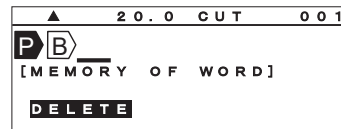

2. Press ◀/▶key or Ten key to input file No.

3. Press to delete the saved word.

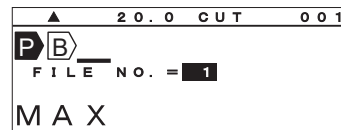
**[INITI. (INITIALIZE)]**

Deleting all of the registered "WORD."

1. Select . And then press .

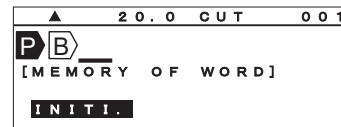

2. Press ◀/▶key to select "YES."

3. Press to initialize.

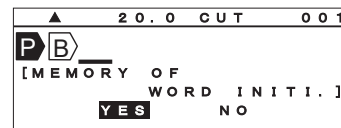

8-13 IMAGE

Press **[SHIFT]** → **[OPTION]**(IMAGE).

Preview a document to get the following information about tubes, tapes, and ID plates before printing.

- 1) Total print length 2) Preview of the document

▲ key: Temporarily stops the “IMAGE” scroll.
 ► key: Increases the scroll speed.
 ◀ key: Reduces the scroll speed.
[ESC]: Cancel the preview.

8-14 ADVANCED SETTINGS

1. Press **[OPTION]**.

The **[PC connection / ADVANCED SETTINGS setting screen]** appears.

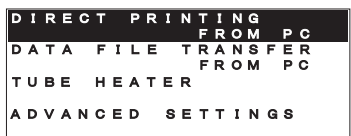

2. Press **▲/▼** key to select “ADVANCED SETTINGS”.



3. Press **[ENTER]**.

The following items are in the “ADVANCED SETTINGS”.

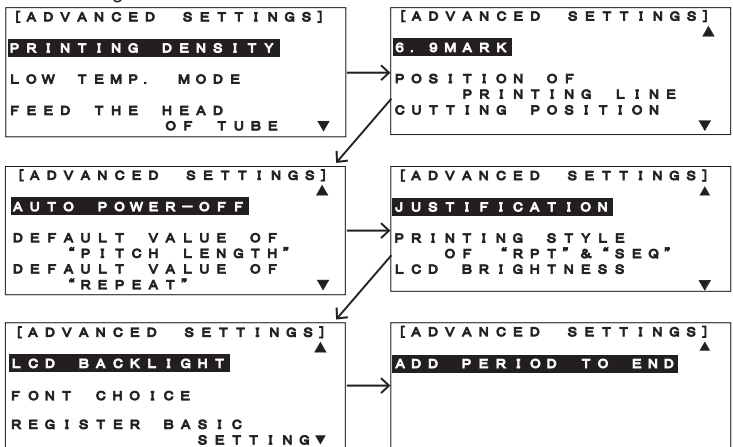

Press **◀/▶/▼/▲** key to select the item to configure, then press **[ENTER]** while the cursor is positioned at the desired item.

Note: Press **[ESC]** key to cancel changes.

8-14-1 PRINTING DENSITY

Adjusting the "PRINTING DENSITY."

When you need to print darker or clearer, adjust it to higher level. When the ink ribbon adhered to the TUBE or TAPE, adjust it to lower level.

By pressing ◀/▶ key, increase or decrease the density level. Press to register the density level.

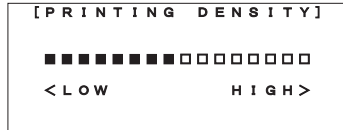

8-14-2 LOW TEMP. MODE

Under low temperature, the printing result might not as good as under normal temperature. In such a case, besides adjusting the "PRINTING DENSITY", the printing result might be improved slightly by activating "LOW TEMP. MODE".

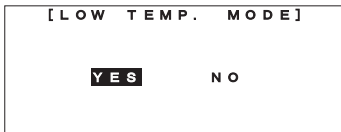

LOW TEMP. MODE	PRINTING SPEED
YES	About 20mm/s
NO	About 40mm/s

Note: When this function activates, printing speed is changed as the above table.

8-14-3 FEED THE HEAD OF TUBE

Setting the "FEED THE HEAD OF TUBE".

After selecting the item by pressing ◀/▶ key, press to register the setting.



Note:

- This function is activated only for printing on tube.
- When "YES" is selected, the head of tube (approx.55mm) is fed without printing before the first block.

8-14-4 "6, 9" MARK

Setting the printing style of 6 and 9 for a document.

After selecting the item by pressing ▲/▼ key, press to register the setting.

Selectable items: (6 9), (6_9_), (6. 9.)

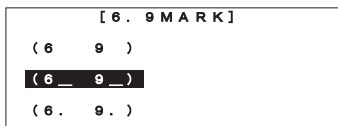

Note:

- When "(6_9_)" is selected, the printing style is like 6 and 9.

8-14-5 POSITION OF PRINTING LINE

Adjusting the "POSITION OF PRINTING LINE."

By pressing ◀/▶ key, changing the vertical position of printing line.

Increment : higher. Decrement : lower. Press to register the setting.

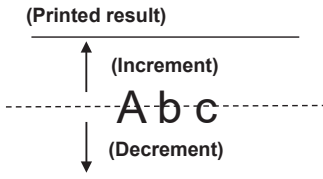

8-14-6 CUTTING POSITION

Adjusting the "CUTTING POSITION."

By pressing ◀/▶ key, changing the cutting position.

Increment : margin at right side getting bigger.

Decrement : margin at left side getting bigger. Press to register the setting.

Setting range: -2.0~+2.0mm



When the print position is off center

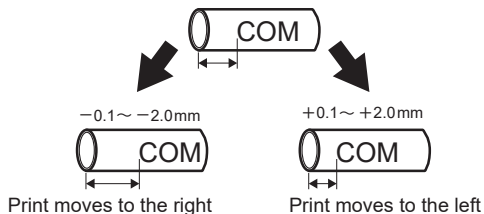

8-14-7 AUTO POWER-OFF

Setting the "AUTO POWER-OFF".

After selecting the item by pressing ◀/▶ key, press to register the setting.



Note: When "YES" is selected, if no key is pressed for about 5 minutes, the machine turns off automatically.

8-14-8 DEFAULT VALUE OF “PITCH LENGTH”

Setting the default value of “PITCH LENGTH.”

Note: The default value is set initially as “TUBE=20mm, TAPE=10mm, and ID PLATE=10mm” at our factory.

After setting the desirable value by pressing ▲/▼/◀/▶ key or Ten key, press to register the setting.

Setting range: Tube = 10.0~150.0mm , TAPE, ID PLATE=4.0~60mm

```

          L E N G T H ]
          T U B E = 2 0 . 0   m m
          O T H E R = 1 0 . 0   m m
  
```

Note : If you press the , the value is initialized to the factory default value.

8-14-9 DEFAULT VALUE OF “REPEAT”

Setting the default value of “REPEAT.”

Note: The default value is set initially as “TUBE = 2pcs, (Tape and ID plate) OTHER = 1PCS” at our factory.

After setting the desirable value by pressing ▲/▼/◀/▶ key or Ten key, press to register the setting.

Setting range : 1~300pcs.

```

          [ R E P E A T ]
          T U B E = 2   P C S
          O T H E R = 1   P C S
  
```

Note : If you press the , the value is initialized to the factory default value.

8-14-10 JUSTIFICATION

Setting the “JUSTIFICATION” for a document in the [NORMAL PRINT MODE].

Note: • This setting is only applied to the [NORMAL PRINT MODE].

- The character arrangement in the [PITCH PRINT MODE] is always “CENTER.”

After selecting the item by pressing ▲/▼ key, press to register the setting.

Selectable items: LEFT, CENTER, RIGHT

```

          [ J U S T I F I C A T I O N ]
          L E F T
          C E N T E R
          R I G H T
  
```

Example:

LEFT	COM
CENTER	COM
RIGHT	COM

8-14-11 PRINTING STYLE OF "RPT" & "SEQ"

Selecting the printing style for the "REPEAT and SEQUENCE".

The default value of the "PRINTING STYLE" is "A : 11, 22, 33" at our factory.

When you use the "REPEAT and SEQUENCE" function at the same time, you can select the printing style from "A : 11, 22, 33" or "B : 123, 123."

Example: REPEAT :2 pcs. SEQUENCE : 01~03

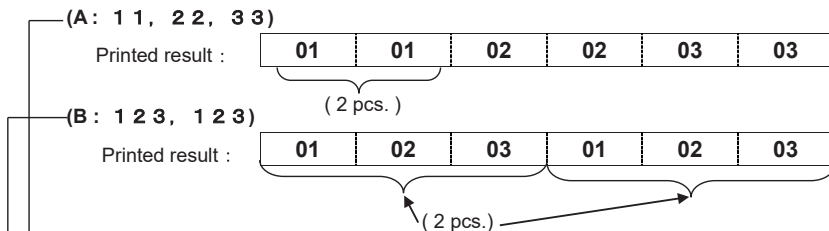

1. Select the "PRINTING STYLE OF [RPT] & [SEQ]" in the "ADVANCED SETTINGS" menu.

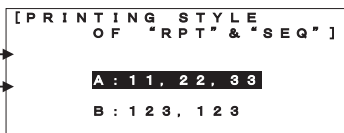

2. Press ▲/▼ to select the printing style.

Note : If you press the **[DELETE]** key, the selection is initialized to the factory default.

3. Press **[ENTER]** key to register the new selection.

8-14-12 LCD BRIGHTNESS

Adjusting the "LCD BRIGHTNESS." When the screen is not visible enough, adjust the "LCD BRIGHTNESS" level.

By pressing ◀/▶ key, increase or decrease the "LCD BRIGHTNESS" level.

Press **[ENTER]** to register the "LCD BRIGHTNESS" level.

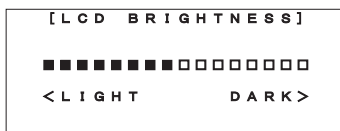

Note: • Without entering the **ADVANCED SETTINGS** menu, the adjustment of the "LCD BRIGHTNESS" is also available by following way.

1. Turn on the power.
2. In the [PRINTED MATERIAL setting screen],
 - To increase the "LCD BRIGHTNESS," press **[P]** key.
 - To decrease the "LCD BRIGHTNESS," press **[L]** key.

• Depending on the temperature, "LCD BRIGHTNESS" adjustment might improve the visibility of the screen.

8-14-13 LCD BACKLIGHT

Adjusting the "LCD BACKLIGHT" power level. To save the power consumption, or to optimize the screen visibility, adjust the "LCD BACKLIGHT" power level.

By pressing ◀/▶ key, select the "LCD BACKLIGHT" power level.

Press to register the "LCD BACKLIGHT" power level.



8-14-14 FONT CHOICES

Select the print font from 4 types of font:

"STANDARD", "CLEAR CHARACTER", "SQUARE SHAPE", and "VIETNAMESE".

1. Select the font with the ▼/▲ keys and press

.

Note: • The actual printed character height depends on the fonts and characters.

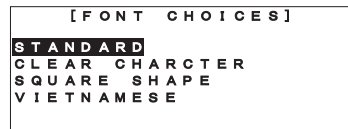

<CLEAR CHARACTER>

A specially designed font to prevent misreading.

Example

0	There is a diagonal line to distinguish it from O (oh).
6 9	The shapes of 6 8 9 have been changed so that it is easily distinguished.
8	The upper circle is made smaller so that you can see the top and bottom clearly.

<SQUARE SHAPE>

A specially designed font that has an aspect ratio (vertical and horizontal ratio) of 1: 1.

Note: The actual font size will be smaller than the set font size. Please adjust the font size before print.

8-14-15 REGISTER BASIC SETTING

Register the basic printing settings which can be applied when selecting the corresponding printed material.

Up to 6 combination patterns can be registered.

1. Select **“REGISTER BASIC SETTING”** from **“ADVANCED SETTING”**.
2. Select **“No.1”** to **“No. 6”** with ▲/▼, and register in the order of **“PRINTING DENSITY”**, **“POSITION OF PRINTING LINE”**, and **“CUTTING POSITION”**.
3. Enter a registration name, and press **[ENTER]**.

8-14-16 PERIOD (POINT/DOT)

You can add a period(point) to the end of every line.

Select **“ADD TO END”** and press **[ENTER]**.

The period(point) is deleted by pressing **“DELETE FROM END”**.

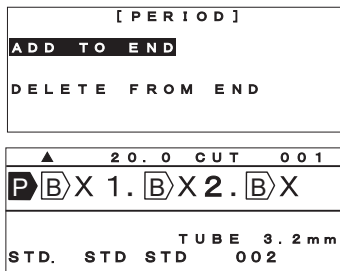

8-15 COPY / PASTE

Copying a block in the document and pasting it to the cursor position.

The setting value (size, character width, repeat and sequential number) of a block can also be copied and pasted.

8-15-1 COPY

1. Press ◀/▶ key, move the cursor under the block you want to copy.

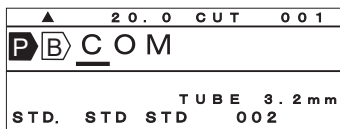

2. Press **[SHIFT]** → **[MEMORY]** (COPY).



8-15-2 PASTE

1. Press ◀/▶ key, move the cursor under the block you want to paste.

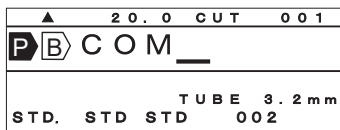

2. Press **[SHIFT]** → **[USB MEM.]**(PASTE).



8-16 INPUT ASSISTANCE FUNCTION

Pressing **[SHIFT]** → **[A/a]** recalls the character entered immediately before.

1. After entering [CONVERTER24 / FAN-TB24V], press **[BLOCK]**.

```

  ▲      2 0 . 0  C U T      0 0 1
A N - T B 2 4 V [B]
          T U B E  3 . 2 m m
S T D .  S T D  S T D      0 0 2

```

2. Pressing **[SHIFT]** → **[A/a]** and "FAN-TB24V" will be displayed automatically. You can also select input candidates with the ▲ / ▼ keys, so press **[ENTER]**.

```

  ▲      2 0 . 0  C U T      0 0 1
A N - T B 2 4 V [B]
F A N - T B 2 4 V
S T D .  S T D  S T D      0 0 2

```

Note: This function is valid only when only one slash [/] is entered.

8-17 MEMORY

8-17-1 INTERNAL MEMORY

The created documents and their setting values can be saved in the internal memory.

The saving capacity is up to 50 files and up to 250,000 characters in total (depending on the file contents).

[←], **[B]**, **[P]** and **[N]** can also be saved.

1. Press **[MEMORY]**. The **[MEMORY setting screen]** appears.

```

[ I N T E R N A L   M E M O R Y ]
[ R E C A L L   S A V E ]
[ D E L E T E   I N I T I A L I Z E ]

```

2. Press ◀/▶/▲/▼ key to select a desired item and press **[ENTER]**.

Selectable items: **RECALL, SAVE, DELETE, INITI. (INITIALIZE)**

[SAVE]

Saving the created document in the selected file No.

1. Select **[SAVE]**. And then press **[ENTER]**.

The **[FILE NO. selection screen]** appears.

```

[SAVE]
FILE NO. = 1
MAX
FILE NAME
P B A 2 B X 1 0
    
```

Note: -If any document is not saved in the selected file No., "NO FILE" appears.

2. Press ◀/▶key or Ten key to select the file No that "NO FILE" is displayed..

Setting range: 1~50

```

[SAVE]
FILE NO. = 2
- NO FILE -
    
```

3. Press **[ENTER]** to save the selected document in the selected file No.
 4. Enter a file name, and press **[ENTER]**.

[RECALL]

Recalling the saved document.

1. Select **[RECALL]**. And then press **[ENTER]**.

The **[FILE NO. selection screen]** appears.

```

[RECALL]
FILE NO. = 1
MAX
P B A 2 B X 1 0
    
```

2. Press ◀/▶key or Ten key to select the desired file No. Press **[ENTER]** to recall the file.

Note: • If a document is existing in the **[INPUT screen]**, the message which asks overwriting appears.

[DELETE]

Deleting the saved document

1. Select **[DELETE]**. And then press **[ENTER]**.
The **[FILE NO. inputting screen]** appears.

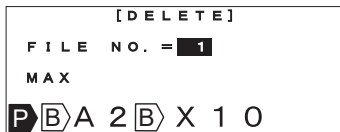

2. Press **◀/▶** key or Ten key to select the desired file No. Press **[ENTER]** to delete the file.

[INITIALIZE]

Deleting all of the file in the internal memory.

1. Select **[INITIALIZE]**. And then press **[ENTER]**.



2. After selecting "YES" by pressing **◀/▶** key, press **[ENTER]** to initialize.

8-17-2 USB MEMORY (EXTERNAL MEMORY)

The documents can be saved in the USB memory (external memory).

The data format can be selected from "CSV" or "LMF" format.

- The "CSV" data can be edited by Excel® for Windows® personal computer. However, it does not include setting values, such as character size.
- The "LMF" data can be edited by MAX original application software "LETATWIN PC EDITOR" for Windows® personal computer.

(See 10: EDITTING DATA IN PERSONAL COMPUTER)

1. Insert the USB memory into LM-550A2/PC. (See 5-6: INSERTING THE USB MEMORY)

2. Press **[USB MEM.]**. The **[USB MEMORY setting screen]** appears.



3. After selecting the item by pressing **▲/▼** key, press **[ENTER]**.

Selectable Item: RECALL, SAVE, DELETE
RECALL= Recalling the file saved in the USB memory.
SAVE =Saving the document in the USB memory.
DELETE = Deleting the file in the USB memory.

4. The following screens are displayed according to the selected item.

Press ▲/▼ key to select the item.

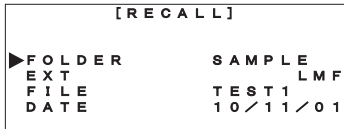

Item	Contents	◀/▶key
FOLDER	Displays the folder name. To create a new folder and save a file in it, input the name within 8 alphanumeric characters.	Displays the previous / next folder.
EXT	Displays the extension. (File format) LMF: ●This is an original extension for LM-550A2 series. All contents of the document and setting are saved. ●To edit the file with "LETATWIN PC EDITOR" in a personal computer, the file must be saved as "LMF" file. CSV: This can be edited with Excel® for Windows® personal computer, but cannot save the setting data.	Selects "LMF" or "CSV."
FILE	Displays the file name. To save, input the file name within 8 alphanumeric characters.	Displays the previous / next file.
DATE	Displays the date when the file is created. To save, input the last two digits of the year/month/date manually.	

5. To save the document, input all of the above items with alphanumeric characters.

The following alphanumeric characters can be input.

-	0	1	2	3	4	5	6	7	8	9	@	A	B	C	D	E	F	G
H	I	J	K	L	M	N	O	P	Q	R	S	T	U	V	W	X	Y	Z

6. After selecting the document, press to execute the selected item.

Note: ● Make sure to input only alphanumeric characters as the folder name and file name.

● When using a new USB memory, create a folder first by inputting a folder name.

When creating a folder, the below message appears.



8-18 TUBE HEATER (only for the CE and A11 model)

In an environment with a temperature of 20°C or less, the tube may become hard, and the printed letters may be blurred or faint.

In this case, you can use a tube heater to warm and soften the tube to improve the print quality. (Usable tube diameter ϕ 2.5 to ϕ 4.2)

1. After entering the data, slide the tube heater down until it clicks.

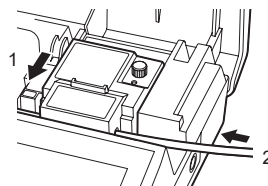

2. Insert the tube through the inlet.

3. Press the **[IMAGE OPTIONS]** , select **[TUBE HEATER]** with **▼** , and press **[ENTER]** .



4. Select YES with the **◀ / ▶** keys and press **[ENTER]** .



The LED lamp for the HEATER part lights up, and machine heats up.

*When the temperature reaches a certain level, heat is automatically stopped and the LED lamp turns off.

*If the tube is hard, please adjust heat by turning the temperature adjustment dial according to the tube and temperature.

*If the tube is hard, please adjust heat by turning the temperature adjustment dial according to the tube and temperature.

	Warning
	Never touch the tube entry/exit points. There is a risk of burns.

5. Press **[PRINT]** .

Printing will start.

- Note:**
- Tube heater compatible tube diameters are ϕ 2.5 to 4.2 mm.
 - If a tube diameter other than the above, or for other materials, the tube heater cannot be turned to ON.
 - After turning the tube heater to ON, if you select an unsupported tube corresponding size or material, the tube warmer will be set to OFF.
 - When the power is turned off, the tube heater setting will be turned off.
 - Please note that if you continually leave the tube in with the tube heater on, the tube may become too warm and printing may not perform normally.
 - The tube heater cannot be used when using a rechargeable battery.
 - At low temperatures (15 ° C or less), battery performance may deteriorate and normal operation may not be possible, so be sure to use the AC adapter.

9. PRINTING

Printing the created document.

9-1 PRINT RANGE SETTING SCREEN

Not only prints all the blocks, a certain range of blocks can be printed as well.

1. Press . [PRINTING RANGE setting screen] appears.

Setting value: COPIES: 1~30
START NO. = The first block to be printed
END NO. = The last block to be printed.

```
[ PRINT ]
      COPIES = 1
START NO. = 1
      END NO. = 3
```

(The function of "COPIES")

LM-550A2 series can print multiple copies of the created document.

If "2" is entered in "COPIES", the machine prints 2 sets of the same document automatically.

2. Press key or Ten key to input the desired number as the "COPIES", "START NO" and the "END NO."
3. Press after inputting the "END NO." Then [PRINTING LENGTH ALIGNMENT screen] appears.

9-2 180° ROTATION PRINT (ONLY TUBE MARKING)

Print data is duplicated pairs with one rotated 180° for printing .

(X01) (10X) (X02) (20X) (X03) (30X)

1. Continuing on the PRINT RANGE SETTING SCREEN, set [180° ROTATION PRINT]. Select [180° ROTATION PRINT] with the / keys and press the . After checking the [PRINT LENGTH screen], press the to start printing.

```
[ PRINT SETTING ]
NORMAL PRINT
180° ROTATION PRINT
```

- Note:**
- If [180° ROTATION PRINT] is set, it will be duplicated automatically. (Printed in double quantity)
 - If the number of continuous prints is set to 2 by when starting (initial value is 2), set the number of continuous prints to 1. (See 8-7 REPEAT)

```
[ PRINT LENGTH ]
      10.0mm
ALIGNMENT = 0mm
```

9-3 PRINTING LENGTH ALIGNMENT

Adjusting the total printing length.

The total printing length of tubes or tapes can be adjusted.

Setting range: -30 to +30mm

Default value: 0mm

1. [PRINTING LENGTH ALIGNMENT screen] appears.

The upper field automatically displays the total calculated length to be printed.

The lower field displays the value to adjust.

```

[ P R I N T   L E N G T H ]
      2 3 0 . 0 m m
A L I G N M E N T =      0 m m
  
```

2. Press ◀/▶ key to decrease or increase the alignment value.

If +8mm is input as the alignment value, 8mm is added to the total calculated printing length.

```

[ P R I N T   L E N G T H ]
      2 3 0 . 0 m m
A L I G N M E N T =      + 8 m m
  
```

3. Press to start to print.

9-4 CONTINUE PRINTING AFTER THE CONSUMABLES RUNNING OUT

When the consumables, such as TUBE and/or INK RIBBON, run out during printing, it is possible to continue printing after replacing them with new ones.

1. During the printing, when the consumables, such as TUBE and/or INK RIBBON run out, the following message appears on the screen.

```

UNPRINTED B L O C K S
R E M A I N I N G
C O N T I N U E   P R I N T I N G ?
      Y E S           N O
  
```

2. Replace the used consumable with new one.
3. Press to continue printing.

Note: When continue printing, the one last printed block might be printed again, to prevent incompletely printed block.

10. EDITING DATA AND PRINTING BY A PERSONAL COMPUTER

LM-550A2 series features USB port for direct connection with Windows® personal computer, as well as USB memory slot for off-the-line data exchange with Windows® personal computer.

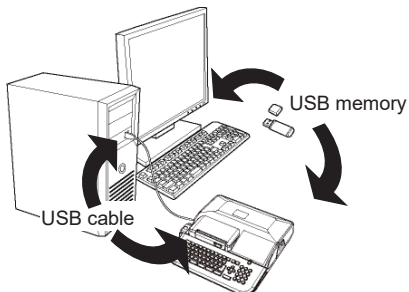

10-1 INSTALLING “LETATWIN PC EDITOR” AND PRINTER DRIVER TO A PERSONAL COMPUTER

(System requirement)

OS : Windows 8.1 /10 ®

(Computer specification must satisfy the minimum system requirements of each OS.)

Note: • For Windows 8.1 /10 ®, compatible with 32-bit and 64-bit version.

10-1-1 INSTALLING “LETATWIN PC EDITOR”

1. Prior to installing “LETATWIN PC EDITOR”, terminate other application software and resident-type software.
2. Please download "LETATWIN PC EDITOR" from the homepage of MAX Co., Ltd.
3. Start installing the software, by clicking the “Install/Uninstall the “LETATWIN PC EDITOR”.
4. Proceed with the installation process, according to the message displayed on the screen.

Note: If the previous version of “LETATWIN PC EDITOR” has been installed to the computer already, make sure to uninstall them first, by using the Setup menu of the “LETATWIN PC EDITOR”
The uninstallation of the software and the driver are separately processed.

During the installation, when selecting the product model and model name are required to select, select LM-550A2 and the proper model name, checking the specification label on the bottom of the machine.

10-1-2 INSTALLING THE PRINTER DRIVER

1. Prior to installing the printer driver, terminate other application software and resident-type software.

Note: If the previous version of “LETATWIN PC EDITOR” and/or the driver has been installed to the computer already, make sure to uninstall them first, by using the Setup menu of the “LETATWIN PC EDITOR”. The uninstallation of the software and the driver are separately processed.

2. Please download the printer driver from the homepage of MAX Co., Ltd.
3. Connect the LM-550A2/PC to the computer with USB cable, then turn it on. Select printed material.

4. Press **[OPTION]**.

The **[PC connection / OPTION setting screen]** appears.

5. Press **▲/▼** key to select “**DIRECT PRINTING FROM PC**”.

```

DIRECT PRINTING
      FROM PC
DATA FILE TRANSFER
      FROM PC
ADVANCED SETTINGS
  
```

6. Press **[ENTER]**.

7. Press **◀/▶** key to select “**YES**”.

```

DELETE INPUTTING FILE
      YES      NO
  
```

8. Press **[ENTER]**.

9. The following message is displayed, which shows the machine is ready to receive data from PC.

```

[PC CONNECTION]

READY TO RECEIVE
      DATA
  
```

10. Start installing the printer driver, by clicking the “Install/Uninstall the printer driver”.

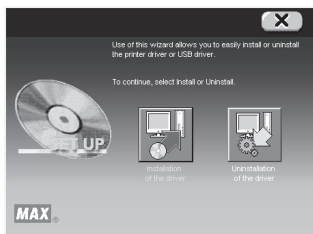

11. Proceed with the installation process, according to the message displayed on the computer.

Note: When the following message is displayed, proceed with the installation process, by clicking [Install this driver software anyway], [Continue Anyway] or [Yes]. Although this following warning message, the product can be used without problems.

12. When the following message appears on the computer, select [Yes. Restarts immediately.], then click [Finish].

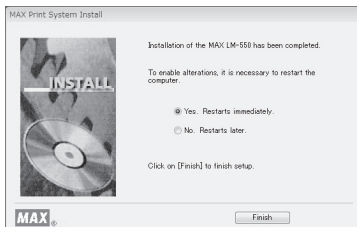

13. Restart the computer. Installation complete.

10-2 EDITING DATA ON A PERSONAL COMPUTER

The “CSV” and “LMF” data can be created and be edited with “LETATWIN PC EDITOR” in the personal computer.

“CSV” data includes only document data.

“LMF” data includes document and setting data.

Note: How to use “LETATWIN PC EDITOR”

Please see the “HELP” menu of “LETATWIN PC EDITOR” after installing it.

The instruction manual is included in the “HELP” menu.

10-3 PRINTING DIRECTLY FROM “LETATWIN PC EDITOR”

With using USB cable connection and “LETATWIN PC EDITOR” for Windows® personal computer, the edited document can be directly printed.

1. Connect the LM-550A2/PC with a personal computer with USB cable.

2. Press .

The **[PC connection / OPTION setting screen]** appears.

3. Press **▲/▼** key to select “DIRECT PRINTING FROM PC”.

D I R E C T P R I N T I N G			
		F R O M P C	
D A T A	F I L E	T R A N S F E R	
		F R O M P C	
T U B E H E A T E R			
A D V A N C E D S E T T I N G S			

4. Press .

5. The following message is displayed, which shows the machine is ready to receive data from PC.

[P C C O N N E C T I O N]			
R E A D Y T O R E C E I V E			
		D A T A	

6. Operate “PRINT” on the “LETATWIN PC EDITOR”.

Note: How to use “LETATWIN PC EDITOR”

Please see the “HELP” menu of “LETATWIN PC EDITOR” after installing it.

The instruction manual is included in the “HELP” menu.

10-4 SAVING DATA DIRECTLY FROM “LETATWIN PC EDITOR”

With using USB cable connection and “LETATWIN PC EDITOR” for Windows® personal computer, the edited document can be directly saved in the LM-550A2 series.

1. Connect the LM-550A2 series with a personal computer with USB cable.

2. Press **[OPTION]**.

The **[PC connection / OPTION setting screen]** appears.

3. Press **▲/▼** key to select “**DATA FILE TRANSFER FROM PC**”.



4. Press **[ENTER]**.

5. The following message is displayed, which shows the machine is ready to receive data from PC.



6. Operate “**TRANSFER DATA**” on the “**LETATWIN PC EDITOR**”. Select the file no. to save the data. **[SETTING RANGE : 0~50]**.

When “0” is selected, the data is loaded into the “INPUT SCREEN”.

When “1~50” are selected, the data is saved into the “INTERNAL MEMORY”.

(SEE 8-17: INTERNAL MEMORY)

Note: The existing data on the “INPUT SCREEN” or in the “INTERNAL MEMORY” is overwritten.

Note: How to use “LETATWIN PC EDITOR”

Please see the “HELP” menu of “LETATWIN PC EDITOR” after installing it.

The instruction manual is included in the “HELP” menu.

11. TROUBLE SHOOTING

11-1 ERROR MESSAGE LIST

Error message	Contents	Countermeasure
OVER INPUT CHARACTER NO.	Number of characters input has exceeded 5,000 characters/file.	Characters more than 5,000/file cannot be input.
OVER INPUT LINE NO.	Number of lines of the document to be input has exceeded 4 lines.	The maximum lines are 4 lines. Delete the texts in the excess line.
OVER INPUT BLOCK NO.	Number of blocks of the document has exceeded 999 blocks/file.	Blocks more than 999/file cannot be input.
UNUSUAL POSITION	The cursor position is not correct.	Move the cursor to the normal position.
UP TO 3PC. IN EACH BLOCK	Attempted to set 4 sequential numbers in one block.	Only 3 sequential number can be set in one block.
UP TO 45PCS IN 1 FILE	Attempted to set more than 46 sequential numbers per file in [PITCH PRINT MODE] .	In [PITCH PRINT MODE] , only up to 45 sequential numbers can be set in a file.
OVER [N] NO.	Attempted to set more than 46 sequential numbers were in [PITCH PRINT MODE] .	In [PITCH PRINT MODE] , only up to 45 sequential numbers can be set in a file.
SET ONLY ONE [N]	Attempted to set more than 2 sequential numbers per file in [NORMAL PRINT MODE] .	In [NORMAL PRINT MODE] , only one sequential number can be set in a file.
DELETE OTHER [P] FIRST	When there are several [P] marks, attempted to delete the first [P] .	Delete all the other [P] , then delete the first [P] .
SET [P] IN THE FIRST BLOCK	In the [NORMAL PRINT MODE] , attempted to input [P] mark in the middle of a document.	When changing from the [NORMAL PRINT MODE] to the [PITCH PRINT MODE] , move the cursor to the top of a document then input [P] .
OVER [P] NO.	Attempted to set 1000 pitch length setting in a document.	Only 999 pitch length settings can be set in a document.
P/LENGTH IS SAME AS LEFT [P]	Input pitch length in the middle of a document, which is same value as previous pitch length.	If pitch length is same as the preceding pitch length, pitch length does not need to be newly set.
NO COPIED DATA	There are no data "COPIED" or "PASTED."	Implement the "PASTE" after "COPY." Note: If the power is turned off, the data copied is lost.
OVER COPY CAPACITY	Attempted to copy a block with more than 51 characters.	Copy the block which has only less than 50 characters.
NO WORD IN THIS BLOCK	Copy a block which has no text.	Copy a block which has some text.

Error message	Contents	Countermeasure
NO ODD NUMBER WITHIN THE RANGE	There are no odd numbers in the set serial numbers.	Reset the start and end values or select [ALL] .
NO EVEN NUMBER WITHIN THE RANGE	There are no even numbers in the set serial numbers.	Reset the start and end values or select [ALL] .
INITIALIZE AFTER DELETE ALL FILES	Attempted to initialize the setting without deleting/clearing the data in a document.	Implement the initialization of setting after deleting/clearing the data in the document.
NO INPUT FILE	Attempted to print without any text to be printed.	Implement the print after inputting the texts.
OVERINPUT CHARACTER SIZE	The input text to be printed is too big, compared to the size of the print material.	Reduce the number of lines, reduce the line space or change the character size to smaller size.
OVER PRINTING SIZE	The input text to be printed is too big, compared to the size of the print material.	Reduce the number of lines, reduce the line space or change the character size to smaller size.
OVER PRINTING LENGTH	The "PRINTING LENGTH" is too long.	Reduce the character space, character width, margin, number of characters or change the character size to smaller size. Or change the print length to longer length.
OVER PITCH LENGTH	The input text is too long for the set "PITCH LENGTH".	Change "PITCH LENGTH". Or reduce the character space, character width, number of characters or change the character size to smaller size.
OVER TOTAL PRINT LENGTH	The total print length is too long. Tube: maximum 100m Tape: maximum 5m ID PLATE : maximum 5m	Reduce the "PRINTING LENGTH", such by dividing the file to two files, or dividing the print range using the print range setting.
OVER THE NUMBER OF COPIES	The total print length is too long, when printing multiple copies. Tube: maximum 100m Tape: maximum 7m	Reduce the number of copies.
NO PRINTED MATERIAL	The consumable has not been set.	Set the print material.
NO INK RIBBON	Ink ribbon runs out. Ink ribbon feed is abnormal.	Replace the ink ribbon or take out the consumables, then set them again. Then continue printing.
COVER IS OPENED	The cover is open while printing.	Printing is not possible when the cover is open. Close it.
THERMAL HEAD IS UNUSUAL	Cannot perform printing because the temperature of the printer head has increased.	After leaving it for a while, print again.

Error message	Contents	Countermeasure
ERROR IN HALF CUT OPERATION	Cannot perform printing because the half cutter unit does not operate normally.	Feed the printed material or replace the half cutter unit.
USB MEMORY UNIDENTIFIABLE	The USB memory has not been formatted properly.	Try the format again. Only "FAT16" or "FAT32" format can be used. The USB memory which has security feature cannot be used.
NO USB MEMORY	The USB memory has not been inserted.	Insert the USB memory.
OVER CAPACITY	The USB memory does not have available space.	Use another USB memory or delete unnecessary files to create space.
CANNOT RECALL THIS FILE	Attempted to read a file which is not compatible with LM-550A2 series.	LM-550A2 series can only read files of "CSV" file format or "LMF" file format.
READ ONLY FILE	Attempt to overwrite or delete the existing read-only file in the USB memory.	To overwrite or delete the read-only file, change its property to rewritable file on a personal computer.
PRIOR TO START PRINTING, LOAD THE MATERIAL (TUBE/TAPE)	Attempt to start printing from "LETATWIN PC EDITOR" on a computer, without setting the print material in the LM-550A2 series.	Set the print material, prior to start printing.
[PC CONNECTION] DATA ERROR	The data received from a computer is abnormal.	Unable to receive the data from other than "LETATWIN PC EDITOR". Press [ESC] and check USB connection with PC, then try again.
[PC CONNECTION] COMMAND ERROR	The command received from a computer is abnormal.	Unable to receive the command from other than "LETATWIN PC EDITOR". Press [ESC] and check USB connection with PC, then try again.
BATTERY VERY LOW	Battery is low	Set the eneloop standard model [BK-3MCC] (recommended) with the remaining charge in the battery.

11-2 TROUBLESHOOTING

Problem	Countermeasure
1. The power is on but: <ol style="list-style-type: none"> 1) The screen does not turn on. 2) The screen is dark (or too light) 	<ul style="list-style-type: none"> • Make sure that the plug and the power cord is securely connected to the wall socket, the adapter and the LM-550A2 series. • The optimum screen brightness depends on the ambient temperature. Adjust it in OPTION menu.
2. When printing on the tube: <ol style="list-style-type: none"> 1) Does not print. 2) The printing is blur (weak). 3) Prints sporadically. 4) The printing is stained (too dense). 5) The tube is shorter than the setting. 6) The characters don't come to the center. 7) The tube is jammed. 8) The white horizontal line is on the printed characters. 	<ul style="list-style-type: none"> • Make sure that the cassette cover has been securely closed. • Make sure that the tube has been set properly. • Make sure that the tube diameter is correct. • Make sure that the ink ribbon has been set properly. • Make sure that there is no dirt, stain, etc adhered to the tube. • Make sure that there is no dirt, stain, etc adhered to the thermal head. • If the ambient temperature becomes lower than 10°C or higher than 35°C, printing faults may occur. <p>Note:</p> <ul style="list-style-type: none"> • Try adjusting "PRINTING DENSITY" in OPTION menu. • When under the low temperature, by making the printing speed the "LOW TEMP. MODE (20.0mm/s)," the printing quality might be slightly improved. <ul style="list-style-type: none"> • Check that the tube is not tangled to the reel. Set the tube in a way that it can be taken out from tube reel with slight force (approx. 200g). • Check that the tube has not been set twisted. • Check that the feeding roller is clean. • Check that there is no waste of the tube caught in the exit. • Remove the jammed tube with using "FEED" function. Do not pull the tube by hand. • The printer head might be damaged. Contact your dealer. <p>Note:</p> <ul style="list-style-type: none"> • Don't use the tube attached solid dirt or foreign material because it may cause trouble of printer head.

Problem	Countermeasure
<p>3. When printing on the tape:</p> <ol style="list-style-type: none"> 1) The tape cannot be set. 2) Does not print. 3) The printing is blur (weak). 4) The printing is stained (too dense). <p>5) The tape is shorter than the setting.</p> <p>6) The characters don't come to the center.</p>	<ul style="list-style-type: none"> • Check the position of the switching lever. • Make sure that the tape has been set properly. • Make sure that the setting value for the tape width is correct. • Make sure that the ink ribbon has been set properly. • Make sure that there is no dirt, stain, etc adhered to the tape. • If the ambient temperature becomes lower than 10°C or higher than 35°C, printing faults may occur. <p>Note:</p> <ul style="list-style-type: none"> • Try adjusting “PRINTING DENSITY” in OPTION menu. <ul style="list-style-type: none"> • Check that the feeding roller is clean. <ul style="list-style-type: none"> • Check that there is no waste of the tape or tube caught in the exit. <p>Note:</p> <ul style="list-style-type: none"> • Try adjusting “CUTTING POSITION” in OPTION menu.
<p>4. Half cutting does not work.</p> <ol style="list-style-type: none"> 1) The tape is not cut. 2) The cutting of the tube is shallow (cannot be cut off). 	<ul style="list-style-type: none"> • Make sure that the half cutter has been set properly. • Make sure that the “Half cutting depth adjustment lever” is properly set. (TUBE position) • Check the cutter has been worn out or not. If the cutter has been used more than 5,000 cuttings, replace it with new one. • Make sure to use the exclusive half cutter LM-HC340 (yellow color). • Check that there is no waste of the tape or tube caught in the exit.
<p>5. Manual cutting does not work.</p>	<ul style="list-style-type: none"> • Check that there is no waste of the tape or tube caught in the exit. • Check the manual cutter has been worn out or not. If the manual cutter has been used more than 30,000 cuttings, ask your dealer for servicing. <p style="text-align: center;">REQUEST</p> <ul style="list-style-type: none"> • The manual cutter cannot be replaced by customers. Contact your dealer for service.
<p>6. Cannot save data to the USB memory.</p>	<ul style="list-style-type: none"> • Check that the USB memory has been completely inserted in the slot. • Check that the available space in the USB memory is sufficient.
<p>7. Can not access to the LM-550A2 series from “LETATWIN PC EDITOR” on a personal computer.</p>	<ul style="list-style-type: none"> • Check that the USB cable has been securely connected between LM-550A2 series and a computer. • Check that the “LETATWIN PC EDITOR” and the driver is properly installed.

- In case the problem is not solved with the above countermeasures, contact your dealer for service.

12. PRODUCT SPECIFICATIONS

ITEMS	CONTENTS	
Dimensions	295(W)x293 (D)x94(H)mm	
Weight	2.3Kg	
Printing method	Thermal transfer method (300 dpi)	
Display	LCD dot matrix: 64 X 160 pixel (Backlit)	
Printing speed	40.0mm/s (Standard) 20.0mm/s (Low temperature mode)	
Maximum printing length	Tube:100m, Tape:5m, ID Plate : 5m Tube:100m, Tape:7m, ID Plate : 7m (Multiple copies)	
Maximum number of characters to input	5,000 characters per file	
Character size	1.3, 2, 3, 4, 6mm height	
Usable tube	Φ1.5 to 8.0 (PVC tube, Shrinkable tube)	
Usable tape	Width 5, 9, 12mm (Max genuine tape)	
Usable ID Plate	2.5mm, 4.1mm, 4.6mm, 6.3mm, 9.0mm	
Tube cutting method	Auto half cut, manual full cut	
Internal memory	250,000 characters (Maximum 50 files)	
External memory	USB memory	
Interface	USB 2.0 full speed	
Power supply	DC12V, 3.0A • Use only specified AC Adapter (100V-240V) included in the package.	LM-550A2/PC C72 LM-550A2/PC BS LM-550A2/PC (IND) LM-550A2B/PC (IND)
	DC12V, 4.2A • Use only specified AC Adapter (100V-240V) included in the package.	LM-550A2BH/PC CE LM-550A2BH/PC A11
Power consumption	30W (max.)	LM-550A2/PC C72 LM-550A2/PC BS LM-550A2/PC (IND) LM-550A2B/PC (IND)
	40W (max.)	LM-550A2BH/PC CE LM-550A2BH/PC A11
Operating environment	10 to 35°C	

 **WARNING**

This product is compliant with class A of EN55032. In a domestic environment this product may cause radiointerference in which case the user may be required to take adequate measures.

FCC Notice
(Class A:LM-550A2BH/PC A11)

Note: This equipment has been tested and found to comply with the limits for a Class A digital device, pursuant to part 15 of the FCC Rules. These limits are designed to provide reasonable protection against harmful interference when the equipment is operated in a commercial environment. This equipment generates, uses, and can radiate radio frequency energy and, if not installed and used in accordance with the instruction manual, may cause harmful interference to radio communications. Operation of this equipment in a residential area is likely to cause harmful interference in which case the user will be required to correct the interference at his own expense.

COMMISSION REGULATION (EU) 2019/1782 of 1 October 2019

AC ADAPTER INFOMATION (only LM-550A2BH/PC CE model)

Manufacturer's name or trade mark, commercial registration number and address	MAX EUROPE B.V. 39093032 Antennestraat 45, 1322 AH Almere, The Netherlands Phone number: (31)36-546-9669
Model identifier	6A-501DA12
Input voltage	AC100-240V
Input AC frequency	50-60Hz
Output voltage	DC12.0V
Output current	4.2A
Output power	50.4W
Average active efficiency	88%
Efficiency at low load (10 %)	79%
No-load power consumption	0.21W

13. APPENDICES

NUMERAL

①	②	③	④	⑤	⑥	⑦	⑧	⑨	⑩
⑪	⑫	⑬	⑭	⑮	⑯	⑰	⑱	⑲	⑳
' 04	' 05	' 06	' 07	' 08	' 09	' 10	' 11	' 12	' 13
' 14	' 15	' 16	' 17	' 18	' 19	' 20	' 21	' 22	' 23
' 24	' 25	' 26	' 27	' 28	' 29	' 30	' 31	' 32	' 33
' 34	' 35	' 36	' 37	' 38	' 39	' 40			
I	II	III	IV	V	VI	VII	VIII	IX	X
i	ii	iii	iv	v	vi	vii	viii	ix	x

ALPHABET IN CIRCLE

A	B	C	D	E	F	G	H	I	J
K	L	M	N	O	P	Q	R	S	T
U	V	W	X	Y	Z				

UNIT

mm	cm	km	mm ²	cm ²	m ²	km ²	ha	mm ³	cm ³
m ³	cc	mℓ	dℓ	ℓ	mg	kg	Å	°C	°K
cal	mV	kV	mA	ns	μs	ms	mW	kW	VA
Ω	kΩ	PF	nF	μF	Hz	KHz	MHz	GHz	dB

OFFICE SYMBOL

No.	KK	TEL	Fax	(株)	(有)	(代)
-----	----	-----	-----	-----	-----	-----

SPERScript

0	1	2	3	4	5	6	7	8	9
-	+	()	a	b	c	x	y	z
α	β	γ							

SUBScript

0	1	2	3	4	5	6	7	8	9
-	+	()	a	b	c	x	y	z
α	β	γ							

ELECTRICAL INSTALLATION①

♂	♂	⊥	⊕	⊕	⊕	⊕	⊕	⊕	⊕
⊕	⊗	⊗	●	⊙	⊙	⊗	⊗	⊙	⊙
⊕	⊕	⊕	⊕	⊕	⊕	⊕	⊕	⊕	⊕
⚠	⊖	⊕	⊕	⊖	⊖	⊖	⊖	⊖	⊖

ELECTRICAL INSTALLATION②

⊕	⊕	⊕	⊕	⊕	⊕	⊕	⊕	⊕	⊕
⊕	⊕	⊕	⊕	⊕					

ELECTRICAL INSTALLATION③

⊕	⊕	⊕	⊕	⊕	⊕	⊕	⊕	⊕	⊕
⊕	⊕	⊕	⊕	⊕	⊕	⊕	⊕	⊕	⊕
⊕	⊕								

ITALIC

<i>α</i>	<i>β</i>	<i>γ</i>	<i>δ</i>	<i>ε</i>	<i>ζ</i>	<i>η</i>	<i>θ</i>	<i>ι</i>	<i>κ</i>
<i>λ</i>	<i>μ</i>	<i>ν</i>	<i>ξ</i>	<i>ο</i>	<i>π</i>	<i>ρ</i>	<i>σ</i>	<i>τ</i>	<i>υ</i>
<i>φ</i>	<i>χ</i>	<i>ψ</i>	<i>ω</i>						

GREEK

Α	Β	Γ	Δ	Ε	Ζ	Η	Θ	Ι	Κ
Λ	Μ	Ν	Ξ	Ο	Π	Ρ	Σ	Τ	Υ
Φ	Χ	Ψ	Ω	α	β	γ	δ	ε	ζ
η	θ	ι	κ	λ	μ	ν	ξ	ο	π
ρ	σ	τ	υ	φ	χ	ψ	ω		

RUSSIAN

А	Б	В	Г	Д	Е	Ё	Ж	З	И	Й	К	Л	М	Н
О	П	Р	С	Т	У	Ф	Х	Ц	Ч	Ш	Щ	Ъ	Ы	Ь
Ю	Я													
а	б	в	г	д	е	ё	ж	з	и	й	к	л	м	н
о	п	р	с	т	у	ф	х	ц	ч	ш	щ	ъ	ы	ь
ю	я													

14. SPECIAL NOTICE FOR DISPOSAL (ONLY in India).

User Information on Electrical & Electronic Equipment to comply with India E-waste (Management) Rules 2016.

Our products comply with the "India E-waste (Management) Rules 2016" and prohibits use of lead, mercury, hexavalent chromium, polybrominated biphenyls or polybrominated diphenyl ethers in concentrations exceeding 0.1 weight % and 0.01 weight % for cadmium, except for the exemptions set in Schedule 2 of the Rule

Our Products contain high quality components and are designed to facilitate recycling. Moreover they are RoHS compliant.

Our products and product packaging are marked with the symbol below.



The symbol indicates that the product must not be treated as municipal waste. It must be disposed of separately via the appropriate return and collection systems available. By following these instructions you ensure that this product is treated correctly and help to reduce potential impacts on the environment and human health, which could otherwise result from inappropriate handling. Recycling of products helps to conserve natural resources and protect the environment.

To comply with E waste management rules the product needs to be handed over to authorized recycler in your area and copy of certificate should be forwarded to INDOMAX, Pune. Alternatively you can return this product to the source from where you have purchased and/or you can send it back to INDOMAX, Pune.

Company: INDOMAX

Address: GAT NO.359/2, M.NO.230/1, SHIVPUR BAUG, SHRIRAM NAGAR, BEHIND HOTEL NEW VILAS, KHED SHIVAPUR, TAL.HAVELI, PUNE-412205, MAHARASHTRA, INDIA

Contact no: +91-90-11011046

E-mail: shinde@indomax.in

Website: www.indomax.in

